

Top Flite Models Champaign, IL  
 Ph: (217) 398-8970, Ext. 5  
 Fax: (217) 398-7721  
[airsupport@top-flite.com](mailto:airsupport@top-flite.com)

# F4U CORSAIR

## WARRANTY

Top Flite® Model Manufacturing Co. guarantees this kit to be free from defects in both material and workmanship at the date of purchase. This warranty does not cover any component parts damaged by use or modification. **In no case shall Top Flite's liability exceed the original cost of the purchased kit.** Further, Top Flite reserves the right to change or modify this warranty without notice.

In that Top Flite has no control over the final assembly or material used for final assembly, no liability shall be assumed nor accepted for any damage resulting from the use by the user of the final user-assembled product. By the act of using the user-assembled product, the user accepts all resulting liability.

**If the buyer is not prepared to accept the liability associated with the use of this product, the buyer is advised to return this kit immediately in new and unused condition to the place of purchase.**

To make a warranty claim send the defective part or item to Hobby Services at this address:

**Hobby Services**  
 3002 N. Apollo Dr. Suite 1  
 Champaign IL 61822 USA

Include a letter stating your name, return shipping address, as much contact information as possible (daytime telephone number, fax number, e-mail address), a detailed description of the problem and a photocopy of the purchase receipt. Upon receipt of the package the problem will be evaluated as quickly as possible.

## SPECIFICATIONS

<b>Wingspan:</b>	86.5 in [2195mm]
<b>Wing Area:</b>	1376 sq in [88.8 dm <sup>2</sup> ]
<b>Weight:</b>	23– 25 lb [10430–11340 g]
<b>Wing Loading:</b>	39– 42 oz/sq ft [119–128 g/dm <sup>2</sup> ]
<b>Length:</b>	70 in [1780mm]
<b>Radio:</b>	7 channel minimum, 10 channel is preferred
<b>Engine:</b>	3.0–4.0 cu in [50–55 cc] two-stroke gasoline engine

**READ THROUGH THIS MANUAL BEFORE STARTING CONSTRUCTION. IT CONTAINS IMPORTANT INSTRUCTIONS AND WARNINGS CONCERNING THE ASSEMBLY AND USE OF THIS MODEL.**

## TABLE OF CONTENTS

<b>INTRODUCTION</b> ..... 2 Academy of Model Aeronautics ..... 2 IMAA ..... 2 Scale Competition ..... 2 <b>IMPORTANT SAFETY PRECAUTIONS</b> ..... 3 <b>DECISIONS YOU MUST MAKE</b> ..... 3 Radio Equipment ..... 3 Engine Recommendations ..... 4 Retractable Landing Gear ..... 4 <b>ADDITIONAL ITEMS REQUIRED</b> ..... 4 Required Hardware & Accessories ..... 4 Optional Supplies & Tools ..... 4 <b>IMPORTANT BUILDING NOTES</b> ..... 4 <b>KIT INSPECTION</b> ..... 5 <b>ORDERING REPLACEMENT PARTS</b> ..... 5 <b>PREPARATIONS</b> ..... 6 Airplane Stand & Protective Pad ..... 6 <b>ASSEMBLE THE WING</b> ..... 6 <b>INSTALL THE MAIN LANDING GEAR</b> ..... 9 <b>FINAL WING ASSEMBLY</b> ..... 12	<b>ASSEMBLE THE FUSELAGE</b> ..... 15 Install the Rudder & Stab/Elevator ..... 15 Install the Tail Wheel Assembly ..... 17 Installing the Fixed Tail Wheel ..... 17 Installing the Retractable Tail Wheel ..... 19 Install the Tail Wheel Doors (Optional) ..... 20 Install the Tail Cone ..... 21 Install the Elevator & Rudder Servos ..... 22 Install the Air Control System ..... 23 Install the Engine, Throttle Servo & Choke Servo ..... 25 Install the Cowl ..... 29 Install the Fuel Tank & Ignition Module ..... 35 Install the Receiver, Battery & Complete the Radio Installation ..... 38 <b>INSTALL THE COCKPIT, PILOT &amp; CANOPY</b> ..... 39 <b>FINISHING TOUCHES</b> ..... 39 Finish the Cowl ..... 39 Apply the Decals ..... 40 <b>GET THE MODEL READY TO FLY</b> ..... 40	Check the Control Directions ..... 40 Set the Control Throws ..... 40 Balance the Model (C.G.) ..... 41 Balance the Model Laterally ..... 42 <b>PREFLIGHT</b> ..... 42 Identify Your Model ..... 42 Charge the Batteries ..... 42 Balance Propellers ..... 42 Ground Check & Range Check ..... 42 <b>ENGINE SAFETY PRECAUTIONS</b> ..... 42 <b>AMA SAFETY CODE (excerpts)</b> ..... 43 General ..... 43 Radio Control ..... 43 <b>CHECK LIST</b> ..... 43 <b>FLYING</b> ..... 44 Fuel Mixture Adjustments ..... 44 Takeoff ..... 44 Flight ..... 44 Landing ..... 44 <b>DLE MOUNTING PATTERN</b> ..... 47
--	---	--

### INTRODUCTION

Of all of the warbirds ever manufactured, none has risen to the level of the Corsair. The Corsair may be the most recognized airplane of WWII and is certainly one of the most unusual looking airplanes to come off the production line. Top Flite is proud to release this classic warbird in an easy to assemble ARF.

For the latest technical updates or manual corrections to the Corsair visit the Top Flite web site at [www.top-flite.com](http://www.top-flite.com). Open the "Airplanes" link and then select the Giant Corsair ARF. If there is new technical information or changes to this model a "tech notice" box will appear in the upper left corner of the page.

### ACADEMY OF MODEL AERONAUTICS

If you are not already a member of the AMA, please join! The AMA is the governing body of model aviation and membership provides liability insurance coverage, protects modelers' rights and interests and is required to fly at most R/C sites.

#### Academy of Model Aeronautics

5151 East Memorial Drive  
Muncie, IN 47302-9252

Ph. (800) 435-9262  
Fax (765) 741-0057



**Or via the Internet at:**  
<http://www.modelaircraft.org>

**IMPORTANT!!!** Two of the most important things you can do to preserve the radio controlled aircraft hobby are to avoid flying near full-scale aircraft and avoid flying near or over groups of people.

#### IMAA

The Top Flite Corsair is an excellent sport-scale model and is eligible to fly in IMAA events. The IMAA (International Miniature Aircraft Association) is an organization that promotes non-competitive flying of giant-scale models. If you plan to attend an IMAA event, obtain a copy of the **IMAA Safety Code** by contacting the IMAA at the address or telephone number below,

or by logging on to their web site at: [www.fly-ima.org/ima/sanction.html](http://www.fly-ima.org/ima/sanction.html).

#### IMAA

205 S. Hilldale Road  
Salina, KS 67401  
(913) 823-5569



### SCALE COMPETITION

Though the Top Flite Corsair is an ARF and may not have the same level of detail as an "all-out" scratch-built competition model, it is a scale model nonetheless and is therefore eligible to compete in the *Fun Scale* class in AMA competition (we receive many favorable reports of Top Flite ARFs in scale competition!). In Fun Scale, the "builder of the model" rule does not apply. To receive the five points for scale documentation, the only proof required that a full size aircraft of this type in this paint/markings scheme did exist is a single sheet such as a kit box cover from a plastic model, a photo, or a profile painting, etc. If the photo is in black and white

other written documentation of color must be provided. Contact the AMA for a rule book with full details.

If you would like photos of the full-size Corsair for scale documentation, or if you would like to study the photos to add more scale details, photo packs are available from:

#### **Bob's Aircraft Documentation**

3114 Yukon Ave Ph: (714) 979-8058  
Costa Mesa, CA 92626 Fax: (714) 979-7279  
e-mail: www.bobsairdoc.com

## **IMPORTANT SAFETY PRECAUTIONS**

### **PROTECT YOUR MODEL, YOURSELF AND OTHERS... FOLLOW THESE IMPORTANT SAFETY PRECAUTIONS**

1. Your Corsair should not be considered a toy, but rather a sophisticated, working model that functions very much like a full-size airplane. Because of its performance capabilities, the Corsair, if not assembled and operated correctly, could possibly cause injury to yourself or spectators and damage to property.

2. You must assemble the model **according to the instructions**. Do not alter or modify the model, as doing so may result in an unsafe or unflyable model. In a few cases the instructions may differ slightly from the photos. In those instances the written instructions should be considered as correct.

3. You must take time to **build straight, true and strong**.

4. You must use an R/C radio system that is in good condition, a correctly sized engine, and other components as specified in this instruction manual. All components must be correctly installed so that the model operates correctly on the ground and in the air. You must check the operation of the model and all components before **every** flight.

5. If you are not an experienced pilot or have not flown this type of model before, we recommend that you get the assistance of an experienced pilot in your R/C club for your first flights. If you're not a member of a club, your local hobby shop has information about clubs in your area whose membership includes experienced pilots.

6. While this kit has been flight tested to exceed normal use, if the plane will be used for extremely high stress flying, such as racing, or if an engine larger than one in the recommended range is used, the modeler is responsible for taking steps to reinforce the high stress points and/or substituting hardware more suitable for the increased stress.

7. **WARNING:** The cowl and other misc. parts included in this kit are made of fiberglass, the fibers of which may cause eye, skin and respiratory tract irritation. Never blow into a part to remove fiberglass dust, as the dust will blow back into your eyes. Always wear safety goggles, a particle mask and rubber gloves when grinding, drilling and sanding fiberglass parts. Vacuum the parts and the work area thoroughly after working with fiberglass parts.

We, as the kit manufacturer, provide you with a top quality, thoroughly tested kit and instructions, but ultimately the quality and flyability of your finished model depends on how you build it; therefore, we cannot in any way guarantee the performance of your completed model, and no representations are expressed or implied as to the performance or safety of your completed model.

**REMEMBER: Take your time and follow the instructions to end up with a well-built model that is straight and true.**

## **DECISIONS YOU MUST MAKE**

This is a partial list of items required to finish the Corsair that may require planning or decision making before starting to build. Order numbers are provided in parentheses.

### **RADIO EQUIPMENT**

The radio equipment and number of channels required to fly the Top Flite Giant Corsair ARF depends on the capabilities of your transmitter and how the servos will be connected.

The Giant Corsair ARF requires a servo to operate the air control valve, throttle servo, two flap servos, two aileron servos, two elevator servos and a rudder servo.

Servos with a minimum of 99 oz-in of torque are required for operating the elevators, rudder, ailerons and flaps. We recommend that metal geared servos also be used. Standard servos may be used for the throttle and choke (the servo operated choke is optional) and a standard servo is required to operate the retract air valve. The following items were used in the testing of this model.

- Futaba® S3305 (FUTM0045) servos were used on all of the control surfaces as well as the tail wheel steering.
- Futaba S3304 (FUTM0027) servos were used on the throttle, choke (optional) and the retract valve.
- Futaba R6014HS (FUTL7645) 14-channel 2.4 GHz FASST™ Receiver. (A 7-channel receiver is the minimum number of channels you may use. This will not allow for the use of the optional choke servo).

A receiver battery with a minimum of 1,000mAh is recommended. 3,000mAh would be optimal for flying the Giant Corsair ARF. The battery voltage should be checked before every flight to be certain it has enough "charge".

In addition to the servos, the following items (or similar items) are also required. The following items were used in the testing of this model. The order numbers shown in parentheses are for Futaba servos.

**NOTE:** The length and quantity of servo extensions and Y-connectors may vary depending on the brand of radio you are using and the radio installation.

- 4 - 24" [610mm] Pro Series Heavy Duty Servo Extensions (HCAM2721) for the ailerons and flaps
- 2 - 6" [152mm] Pro Series Heavy Duty Servo Extensions (HCAM2701)

Depending on your choice of receiver and the number of channels you will be using you may have to use a "Y" harnesses on the aileron, flaps and elevator. (FUTM4130)

- 1500mAh NiCd receiver battery or equivalent (FUTM1285).
- 2 - Heavy duty switch harness (FUTM4385).
- 2 - Earnst Charge Receptacle (ERNM3001).
- 2 - 1" Servo arms (FUTM2120)

## ENGINE RECOMMENDATIONS

The recommended engine size range for the Corsair is 3.0 – 4.0 cu in [50–55cc] two-stroke gasoline engine. All of our testing was completed with the DLE 55 (DLEG0055) and the J'TEC Pitts Style Wraparound Muffler (JTTCG1035). Another good choice would be the O.S. GT55 (OSMG1555). Remember that this is a scale model that is intended to fly at scale-like speeds, so throttle management should be practiced.

**NOTE:** Instructions for mounting every possible engine cannot be incorporated into this manual. Modelers using other engines should refer to this instruction manual as a guide for mounting their engine in a similar way.

## RETRACTABLE LANDING GEAR

The Top Flite Giant Corsair ARF requires the use of retractable landing gear. This model is designed for Robart pneumatic retracts. Following is the complete list of items required to install the Robart retracts:

- Robart Main Gear for the Top Flite Giant F4U Corsair (ROBQ1655)
- Robart Fork Pneumatic Retract Tail Wheel (ROBQ2230)
- Robart Large Scale Deluxe Air Control Kit (ROBQ2305)
- Robart High Pressure Air Tubing 10' (ROBQ2369)

**NOTE:** An air pump will also be required to pressurize the air tank. The Robart hand pump could be used but is not practical because of the large capacity of the air tank in this model. A small, 12V electric pump is recommended and can be purchased at an automotive or hardware store.

## ADDITIONAL LANDING GEAR OPTION

Just as we were putting this manual together Robart introduced a new electric retract option. This will drop into the same opening as the pneumatic landing gear. For more information on these turn to page 46 of this manual.

## ADDITIONAL ITEMS REQUIRED

### REQUIRED HARDWARE & ACCESSORIES

This is the list of hardware and accessories required to finish the Corsair. Order numbers are provided in parentheses.

- R/C foam rubber (1/4" [6mm] - HCAQ1000, or 1/2" [13mm] - HCAQ1050)
- 1" [25mm] Servo Arm (FUTM2120 for Futaba servos)
- 3' [900mm] gasoline fuel tubing (GPMQ4135)
- 1 oz. [30g] Thin Pro™ CA (GPMR6002)
- 1 oz. [30g] Medium Pro CA+ (GPMR6008)
- Pro 30-minute epoxy (GPMR6047)
- Pro 6-minute epoxy (GPMR6045)
- Silver solder w/flux (STAR2000)
- Hobbico® Soldering Iron 60 Watt (HCAR0776)
- #1 Hobby knife (HCAR0105)
- #11 blades (5-pack, HCAR0211)
- R/C-56 canopy glue (JOZR5007)
- Epoxy brushes (6, GPMR8060)
- Mixing sticks (50, GPMR8055)
- Mixing cups (GPMR8056)
- Masking tape (TOPR8018)
- Threadlocker thread locking cement (GPMR6060)
- Denatured alcohol (for epoxy clean up)
- Panel Line Pen (TOPQ2510)
- Rotary tool such as Dremel®
- Rotary tool reinforced cut-off wheel (GPMR8200)
- Drill bits: 1/16" [1.6mm], 1/8" [3.2mm], 5/32" 4mm, 5/64" [2mm], 3/32" [2.4mm], 7/64" [2.8mm], 3/16" [4.8mm], 1/4" [6.4mm].

### OPTIONAL SUPPLIES AND TOOLS

Here is a list of optional tools mentioned in the manual that will help you build the Corsair.

- 21<sup>st</sup> Century® sealing iron (COVR2700)
- 21<sup>st</sup> Century iron cover (COVR2702)
- 2 oz. [57g] spray CA activator (GPMR6035)

- 4 oz. [113g] aerosol CA activator (GPMR634)
- Epoxy brushes (6, GPMR8060)
- Mixing sticks (50, GPMR8055)
- Mixing cups (GPMR8056)
- Denatured alcohol (for epoxy clean up)
- Panel Line Pen (TOPQ2510)
- Rotary tool such as Dremel
- Rotary tool reinforced cut-off wheel (GPMR8200)

## IMPORTANT BUILDING NOTES

- There are three types of screws used in this kit:

**Sheet Metal Screws** are designated by a number and a length. For example #6 × 3/4" [19mm].

*This is a number six screw that is 3/4" [19mm] long.*



**Machine Screws** are designated by a number, **threads per inch**, and a length. For example 4-40 × 3/4" [19mm].

*This is a number four screw that is 3/4" [19mm] long with forty threads per inch.*

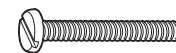

**Socket Head Cap Screws (SHCS)** are designated by a number, **threads per inch**, and a length. For example 4-40 × 3/4" [19mm].

*This is a 4-40 SHCS that is 3/4" [19mm] long with forty threads per inch*



- When you see the term **test fit** in the instructions, it means that you should first position the part on the assembly **without using any glue**, then slightly modify or *custom fit* the part as necessary for the best fit.
- Whenever the term **glue** is written you should rely upon your experience to decide what type of glue to use. When a specific type of adhesive works best for that step, the instructions will make a recommendation.
- Whenever just **epoxy** is specified you may use **either** 30-minute (or 45-minute) epoxy **or** 6-minute epoxy. When 30-minute epoxy is specified it is

**highly** recommended that you use only 30-minute (or 45-minute) epoxy, because you will need the working time and/or the additional strength.

- **Photos** and **sketches** are placed **before** the step they refer to. Frequently you can study photos in following steps to get another view of the same parts.
- The Corsair is factory-covered with Top Flite MonoKote® film. Should repairs ever be required, MonoKote can be patched with additional MonoKote purchased separately. MonoKote is packaged in six-foot rolls, but some hobby shops also sell it by the foot. If only a small piece of MonoKote is needed for a minor patch, perhaps a fellow modeler would give you some. MonoKote is applied with a model airplane covering iron, but in an emergency a regular iron could be used. A roll of MonoKote includes full instructions for application. Following are the colors used on this model and order numbers for six foot rolls.

**Flat Insignia Blue** (TOPQ0507)

## KIT INSPECTION

Before starting to build, take an inventory of this kit to make sure it is complete, and inspect the parts to make sure they are of acceptable quality. If any parts are missing or are not of acceptable quality, or if you need assistance with assembly, contact **Product Support**. When reporting defective or missing parts, use the part names exactly as they are written in the Kit Contents list.

### Top Flite Product Support

3002 N Apollo Drive, Suite 1  
Champaign, IL 61822

Ph: (217) 398-8970, ext. 5 Fax: (217) 398-7721  
E-mail: [airsupport@greatplanes.com](mailto:airsupport@greatplanes.com)

## ORDERING REPLACEMENT PARTS

Replacement parts for the Top Flite Giant Scale Corsair ARF are available using the order numbers in the **Replacement Parts List** that follows. The fastest, most economical service can be provided by your hobby dealer or mail-order company.

To locate a hobby dealer, visit the Top Flite web site at [www.top-flite.com](http://www.top-flite.com). Select "Where to Buy" in the menu across the top of the page and follow the instructions provided to locate a U.S., Canadian or International dealer.

Parts may also be ordered directly from Hobby Services by calling (217) 398-0007, or via facsimile at (217) 398-7721, but full retail prices and shipping and handling charges will apply. Illinois and Nevada residents will also be charged sales tax. If ordering via fax, include a Visa® or MasterCard® number and expiration date for payment.

Mail parts orders **Hobby Services**  
and payments by 3002 N Apollo Drive, Suite 1  
personal check to: Champaign IL 61822

Be certain to specify the order number exactly as listed in the **Replacement Parts List**. Payment by credit card or personal check only; no C.O.D.

If additional assistance is required for any reason contact **Product Support**

**by e-mail at**

[productsupport@top-flite.com](mailto:productsupport@top-flite.com)

**or by telephone at**

(217) 398-8970

### REPLACEMENT PARTS LIST

Order No.	Description
TOPA1850	Wing Kit
TOPA1851	Fuse Kit
TOPA1852	Tail Set
TOPA1853	Cowl
TOPA1854	Canopy
TOPA1855	Spinner
TOPA1856	Cockpit kit
TOPA1857	Landing gear covers
TOPA1858	Tail cover
TOPA1859	Dummy engine
TOPA1860	Decal Sheet
TOPA1861	Fiberglass parts set



## PREPARATIONS

- ❑ 1. If you have not done so already, remove the major parts of the kit from the box and inspect for damage. If any parts are damaged or missing, contact Product Support at the address or telephone number listed in the “Kit Inspection” section on page 5.



- ❑ 2. Use a covering iron with a covering sock on high heat to tighten the covering if necessary. Do this for all of the components of the model. Apply pressure over sheeted areas to **thoroughly** bond the covering to the wood. Refer to the separate instruction sheet titled **How To Tighten Covering On ARF Models**. Follow the instructions to tighten the covering. If you prefer to get started on assembly right away, the tightening process could be done later (but it is usually easiest to do while the model is still in separate pieces).

- ❑ 3. Pull on all control surfaces to be sure all hinges are securely glued in place.

### AIRPLANE STAND AND PROTECTIVE PAD

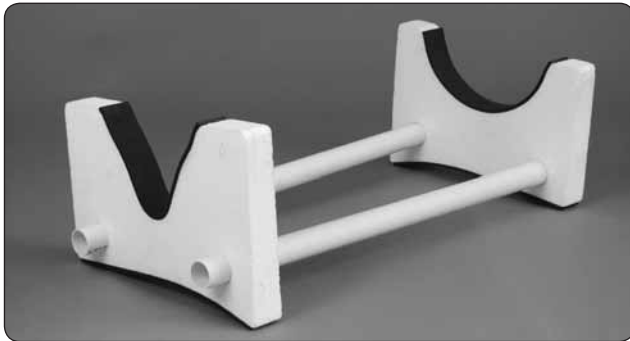

Your kit includes a foam stand and a protective pad to help prevent “hangar rash” during the assembly process.

The foam stand is also a great aid when installing the wing to the fuselage at the airfield. To assemble the stand, slide the two plastic tubes into the foam cradles. One side of the cradle fits the fuselage.



When the riser is added it offers protection to the fin/rudder from the bench.



The other side of the cradle matches the contour of the wing, allowing the cradle to be used for a wing holder.

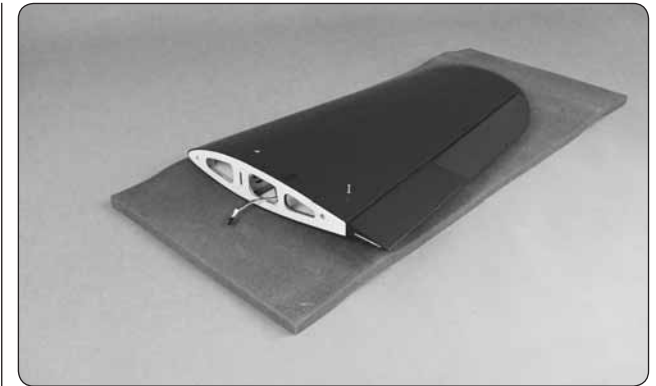

The foam pad can be used on your workbench to provide cushioning for the components when working with them on your workbench.

## ASSEMBLE THE WING

**Note:** Throughout this instruction manual you will be instructed to use screws to secure different parts. **In all cases**, whenever a screw is threaded into wood sheeting or wood blocks, we recommend that you install the screw and then remove it. Apply a drop of thin CA glue into the hole to harden the threads. After the glue has hardened, re-install the screw. Following this step will insure that you have a solid thread for your screws.



- ❑ ❑ 1. Begin with your right **wing panel** first so your assembly matches the photos in the manual. Cut three arms from a servo horn, leaving a single servo arm. The distance from the center of the arm to the outer hole should be approximately 3/4" [19mm]. Center the servo and install the arm as shown. Install the rubber grommets and eyelets on the servo.

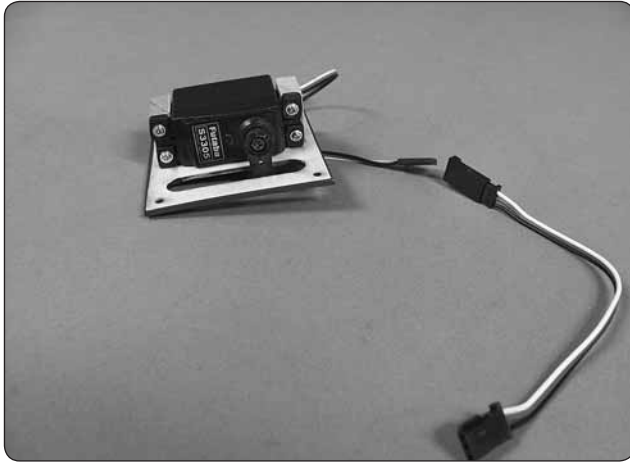

□ □ 2. Remove the aileron servo cover from the bottom of the wing. Place your servo between the servo mounting blocks located on the bottom of the cover. Drill a 1/16" [1.6mm] hole through each of the servo mounting holes into the hardwood block. Install the servo to the servo cover with the screws included with your servo. Attach a 6" [152mm] servo extension to the servo lead. Secure the lead with heat shrink tubing, tape or some other method to assure the leads stay connected.

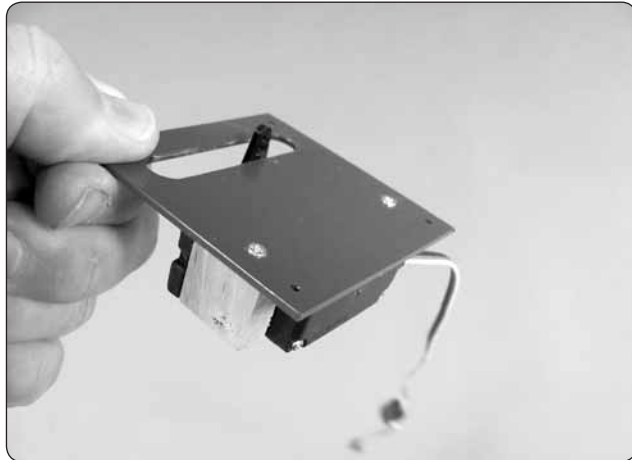

□ □ 3. On the other side of the servo cover drill a 1/16" [1.6mm] hole through the servo cover and into each of the hardwood blocks. Secure the block to the cover with a #2 x 3/8" [9.5mm] wood screw in each of the holes you drilled.

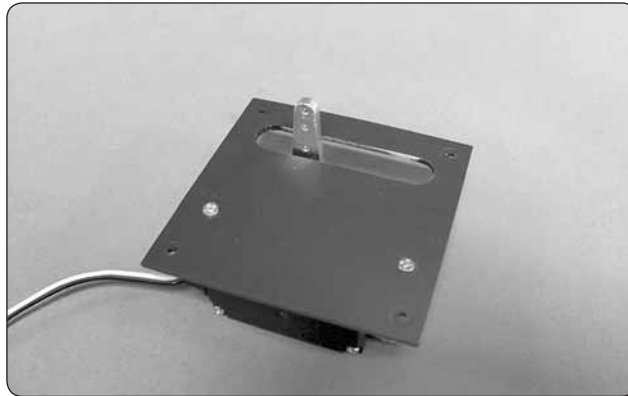

□ □ 4. With another servo, center the servo and install a 1" [25mm] servo arm (FUTM2120 for Futaba servos). Remove the flap servo cover from the wing and install the servo using the same technique used for the aileron. Be sure to install the #2 x 3/8" [9.5mm] wood screw in each of the holes you drilled.

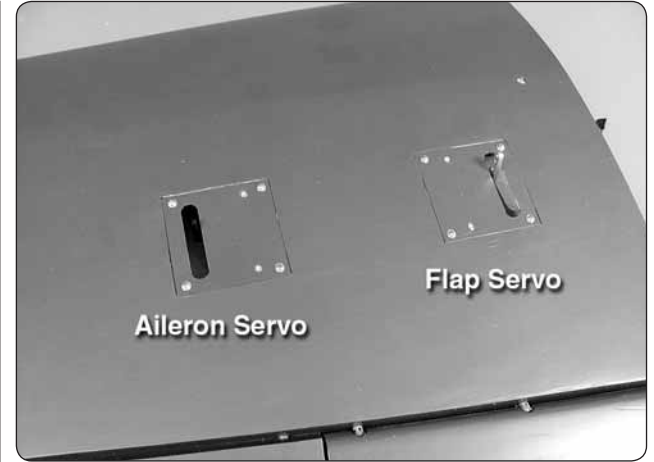

□ □ 5. There is a string that goes through the wing and is attached to the root rib of the wing panel. If needed, tie the aileron servo lead to the string and then pull the lead through the wing. (Since you are passing the lead through a very short distance in the wing you probably do not need to use the string). Secure the aileron servo cover with four #2 X 3/8" [9.5mm] screws and four #2 flat washers.

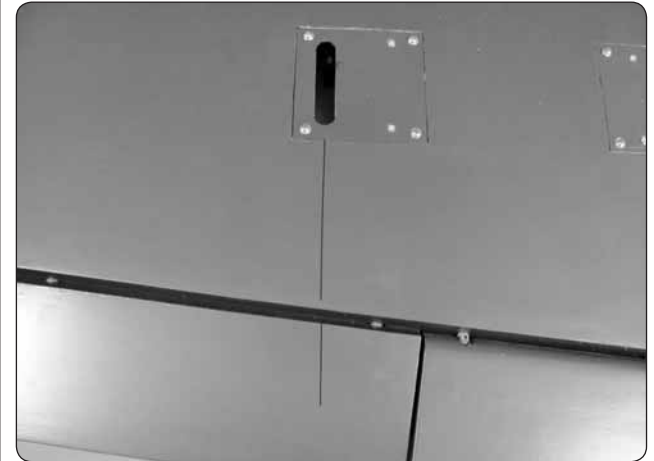

□ □ 6. Using a fine tip marker draw a line from the servo arm toward the aileron. Under the skin of the aileron there is a plywood plate. Place a large black nylon control horn onto the aileron so that the horn is in line with the line you have drawn. Holes in the horn should be positioned over the hinge line.



□ □ 7. Drill a 3/32" [2.4mm] hole through each of the mounting holes in the control horn, drilling into the plywood plate. *Do not drill through the top of the aileron.* Secure the control horn with four #4 × 1/2" [13mm] screws. *(Be sure you install the screw and then remove it. Apply a drop of thin CA glue into the holes as instructed at the beginning of this section of the manual).*



□ □ 8. On the threaded end of a 4-40 × 5-3/4" [146mm] wire install a 4-40 nut, silicone clevis keeper and threaded clevis. Install the clevis into the second hole from the end of the **clevis**. Install a 4-40 solder clevis into the outer hole of the servo horn. **Be sure the servo and the aileron are centered.** Make a mark on the wire where it passes through the solder clevis. Cut the wire on that mark. Remove the clevises and wire from the control horn and servo arm. Solder the solder clevis to the wire. If you are not familiar with solder techniques use the method in the "Hot Tip" that follows this step.



# Hot Tip

## HOW TO SOLDER

1. Use denatured alcohol or other solvent to thoroughly clean the pushrod. Roughen the end of the pushrod with coarse sandpaper where it is to be soldered.

2. Apply a few drops of soldering flux to the end of the pushrod, then use a soldering iron or a torch to heat it. "Tin" the heated area with silver solder by applying the solder to the end. The heat of the pushrod should melt the solder – not the flame of the torch or soldering iron – thus allowing the solder to flow. The end of the wire should be coated with solder all the way around.

3. Place the clevis on the end of the pushrod. Add another drop of flux, then heat and add solder. The same as before, the heat of the parts being soldered should melt the solder, thus allowing it to flow. Allow the joint to cool naturally without disturbing. Avoid excess blobs, but make certain the joint is thoroughly soldered. The solder should be shiny, not rough. If necessary, reheat the joint and allow to cool.

4. Immediately after the solder has solidified, but while it is still hot, use a cloth to quickly wipe off the flux before it hardens. **Important:** After the joint cools, coat the joint with oil to prevent rust. **Note:** Do not use the acid flux that comes with silver solder for electrical soldering.



This is what a properly soldered clevis looks like – shiny solder with good flow, no blobs and flux removed.

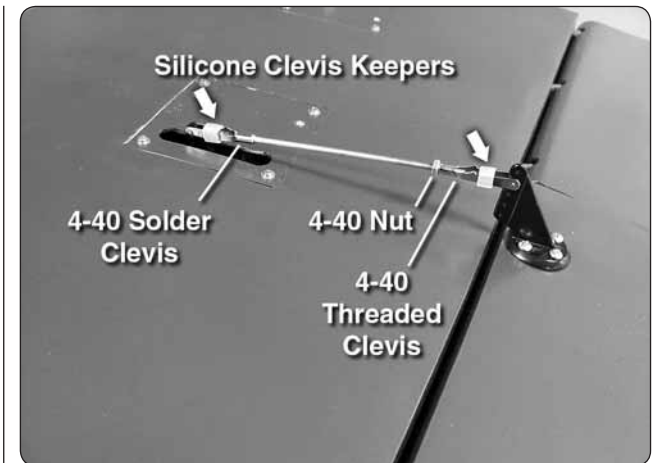

□ □ 9. Install the pushrod assembly to the servo arm and the clevis. Be sure to install a silicone clevis keeper onto both clevises.

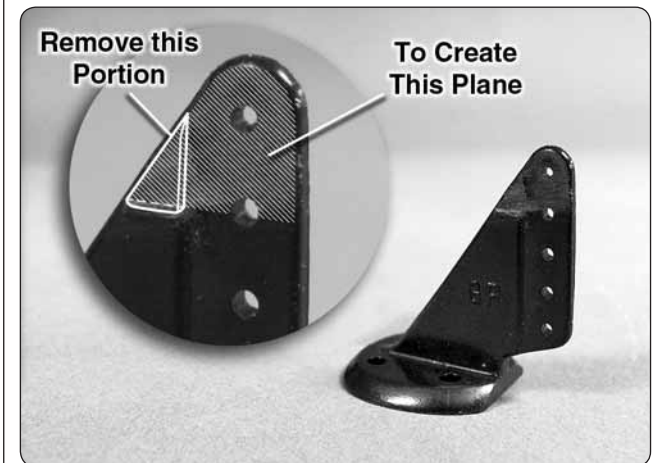

□ □ 10. The photo above shows how the clevis has been modified for installation in the next step. Use a sanding bar or moto-tool with a sanding drum to remove the material on the top 1/4" [6mm] of the clevis. The clevis needs to be even in this area on both sides of the clevis.



❑❑ 11. Install another control horn on the flap using the same technique used for the aileron. **NOTE:** The flap control horn should be installed as shown here. This gives a better mechanical advantage to the servo for operating the flaps.

❑❑ 12. Install the flap servo cover, securing it with four #2 x 3/8" [9.5mm] screws and #2 flat washers

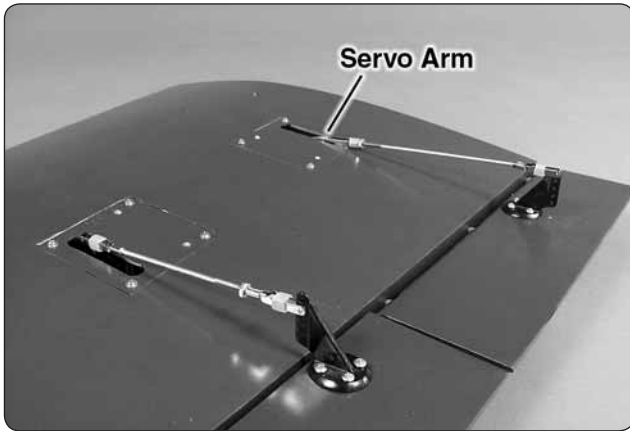

❑❑ 13. Position the flap to its fully retracted position and position the servo arm so that it is rotated back towards the trailing edge of the wing. Make the flap pushrod wire assembly using the same techniques used for the ailerons in step #8. When you have completed the pushrod assembly install the pushrod to the flap control horn and the servo arm as in step 9.

❑❑ 14. Repeat steps 1-13 for the left wing panel.



Early in the Pacific War, US Navy and Marine Corps fighter pilots found themselves outclassed by the agile and well-armed Japanese A6M Zero, but even then work was underway to provide them with better aircraft. One of those better aircraft was the Vought "F4U Corsair", a rugged, powerful, and somewhat unforgiving aircraft that featured a distinctive inverted gull wing.

### INSTALL THE MAIN LANDING GEAR

**Note:** Just a reminder, whenever a screw is threaded into wood sheeting or wood blocks we recommend that you install the screw and then remove it. Apply a drop of thin CA glue into the hole to harden the threads. After the glue has hardened, re-install the screw.

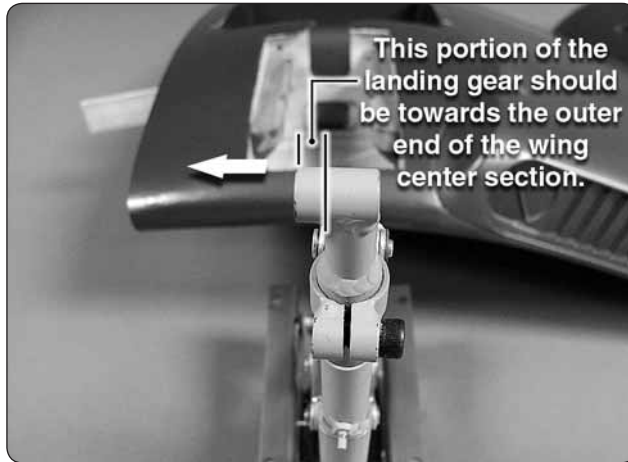

❑❑ 1. Before beginning your installation you need to determine which of the landing gear is the right and left. When installing the landing gear the longer half of the landing gear foot should be towards the outer end of the wing center section. Start with the installation of the left landing gear (as viewed from the top rear) so your work matches the photos shown here.



❑❑ 2. Cut two pieces of differently colored air line 30" [762mm] in length. Using masking tape, tightly tape the two lines together. Taped inside the wing is a string. Securely tie the string around the end of one of the air lines below the masking tape.

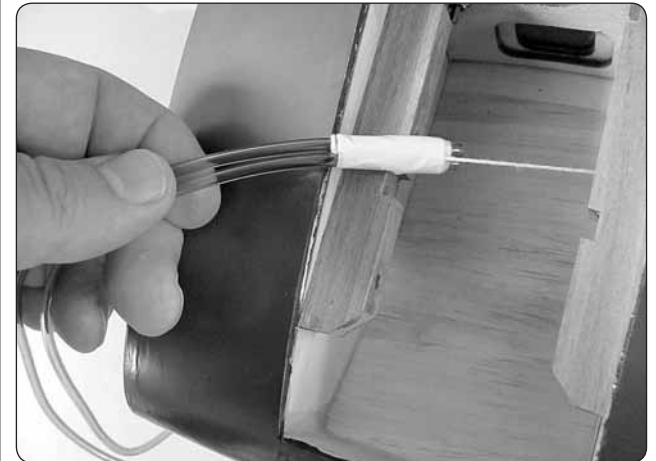

❑❑ 3. Pull the string forward toward the end of the two air lines. Tape the string to the air line, keeping the string as close to the center of the two air lines as possible. It is a tight fit to pull the air line through the wing so the closer you can keep the string to the center of the two air lines the easier it will be to pull them through the wing.

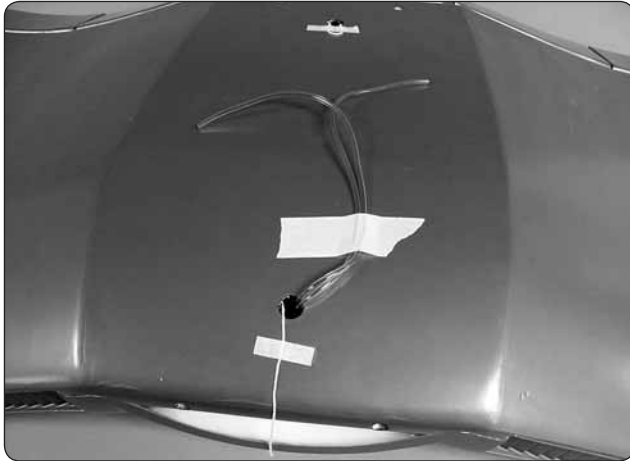

□ □ 4. On the top of the wing center section there is a hole located at the **front** of the wing where you will find a string attached. **Gently** pull the string that the air line is attached to, pulling the air line out of the hole. **Do not pull too hard causing the string to break!** If the lines get caught on a rib while pulling the air line through the wing, pull the air line and string back out, re-position where the string is taped to the lines and try pulling the line through again. Should you break the string it will be very difficult to feed a new string into the wing. Tape the air line to the top of the wing to prevent the lines from falling back into the wing.

□ 5. Repeat this for the left side of the wing.



□ □ 6. Install each of the two air lines onto the air in / out ports on the air cylinder. Make note of which color air line you install on each so that you install them the same way when installing the remaining landing gear.

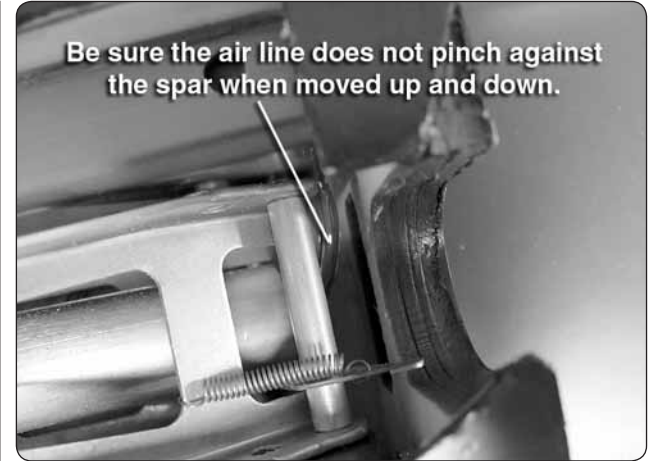

□ □ 7. Place the landing gear on the landing gear rails. Manually move the landing gear leg up and down. You will see that the air cylinder moves forward and aft when the leg moves. The landing gear is properly positioned on the rails when you can move the landing gear leg up and down without the air line being pinched at the back of the cylinder against the wing spar.

□ □ 8. Double check your placement of the landing gear on the rails, then use a 1/16" [1.6mm] drill bit to drill a pilot hole through each of the mounting holes in the landing gear mounting plates and into the hardwood mounting rails.

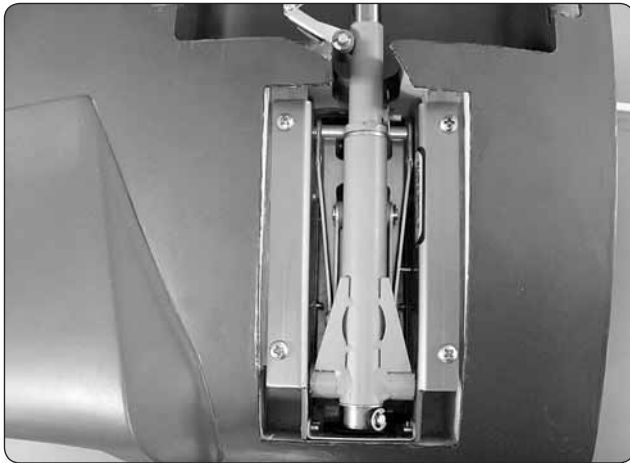

□ □ 9. Using the pilot holes you drilled as your guide, drill a 7/64" [2.8mm] hole through each of the pilot holes and into the hardwood rails. Secure the landing gear to the mounting rails with four #6 × 1/2" [13mm] screws.

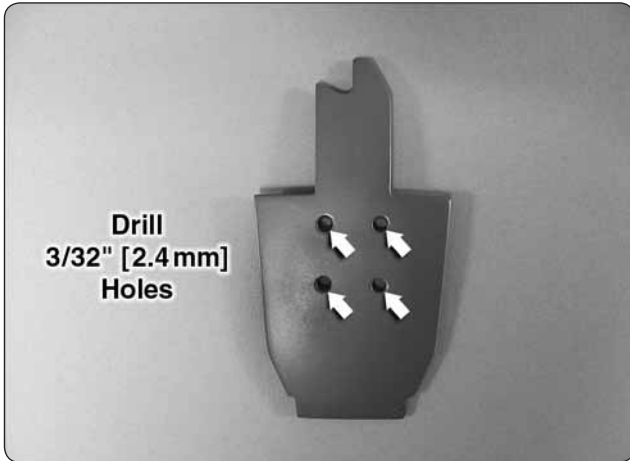
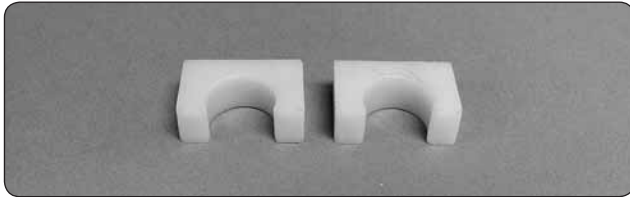

□ □ 10. Locate two of the nylon landing gear door mounts and the right landing gear door. Drill a 3/32" [2.4mm] hole centered through each of the four molded recesses in the door.

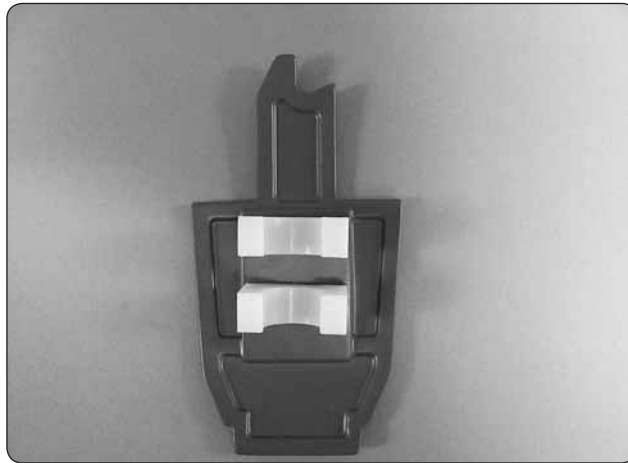

□ □ 11. Position the nylon landing gear door mounts on the back of the landing gear door, centering the mounts on the door and the holes you drilled. Now that you know where to place the mounts, tack glue the mounts to the door with CA glue. Once the glue has hardened turn the door over and drill a 1/16" [1.6mm] hole through each of the holes you drilled and into the nylon mounts. Attach the mounts to the door with four #2 × 3/8" [9.5mm] wood screws.

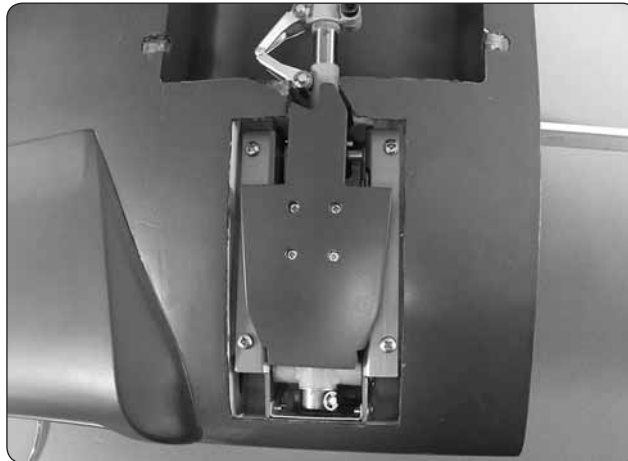

□ □ 12. Snap the doors onto the leg of the landing gear. To adjust the final position of the doors slide the door up or down on the landing gear.

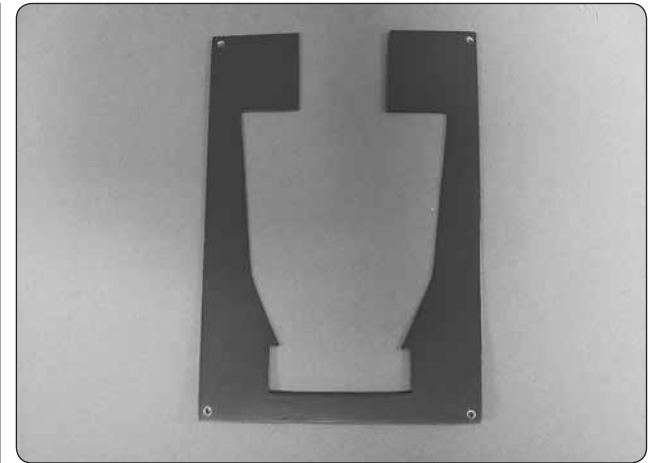

□ □ 13. Locate the door cover. Drill a 3/32" [2.4mm] hole in each corner of the cover. Keep the holes as close to the corners as possible.



□ □ 14. Place the door cover over the opening for the landing gear. Drill 1/16" [1.6mm] holes through the holes in the door cover and into the wing. Secure the cover with four #2 × 3/8" [9.5mm] wood screws. Be sure to apply some thin CA into the holes to harden the threads.

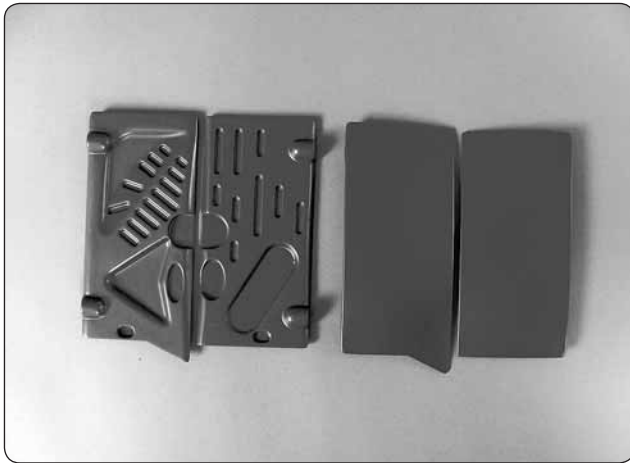

You now have a decision to make in completing the installation of the landing gear. We have provided scale inner doors for the more scale minded modeler. Because of the costs and extra skill required for this we have not engineered the installation of the doors as part of the assembly process. We have provided the doors so if you choose to have functional doors you will have something to work with. If you will not be installing the doors move on to step 15.



15. Locate four  $\frac{3}{8}$ "  $\times$   $\frac{3}{8}$ "  $\times$   $\frac{1}{4}$ " wood blocks. Glue them flush with the surface of the wing over the openings in the wheel well. (Do not be concerned about the pre-drilled holes that you will cover. These holes are for hinges if you would be installing doors). You may need to slightly trim the block to get a good fit.

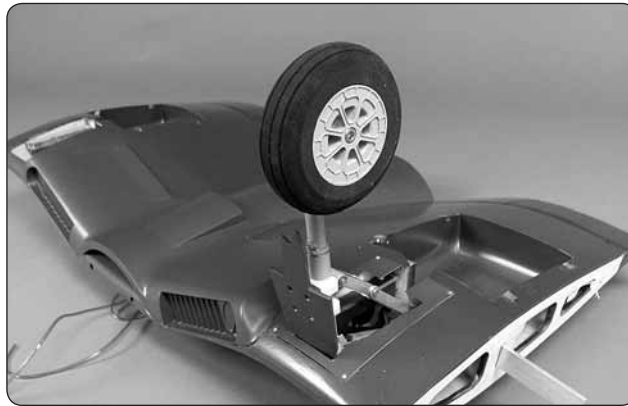

16. Using the axle and hardware that came with the retractable landing gear, install the wheel to the landing gear. The center hub of the wheel may need to be opened slightly. If your axle is a bit snug open the wheel hub with a  $\frac{1}{4}$ " [25mm] drill bit. Be sure you use thread locker on the axle and axle nut.

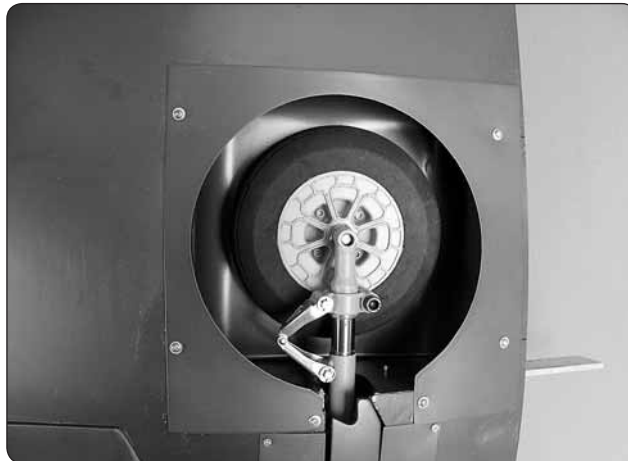

17. Lower the landing gear so the wheel is in the wheel well. Place a wheel well cover over the opening and center the cover over the wheel and the four wood blocks you glued in place. Be sure the wheel can be raised and lowered without touching the cover. Drill six  $\frac{1}{16}$ " [1.6mm] holes through the cover and into the four wood blocks and the wing at the location shown in the photo. Secure the cover to the wing with six #2  $\times$   $\frac{3}{8}$ " [9.5mm] screws and #2 flat washers.

18. Repeat steps 6 – 17 for the left landing gear.

## FINAL WING ASSEMBLY



1. Locate two nylon pins. Test fit the pins into the holes in the leading edge of the wing. When you are satisfied with the fit, apply epoxy to the ribbed end of the pins and into the holes in the wing.

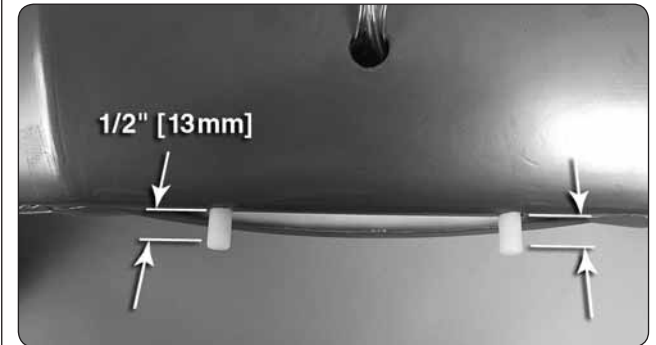

Insert the pins into the holes leaving approximately  $\frac{1}{2}$ " [13mm] of the pin extending from the leading edge of the wing.

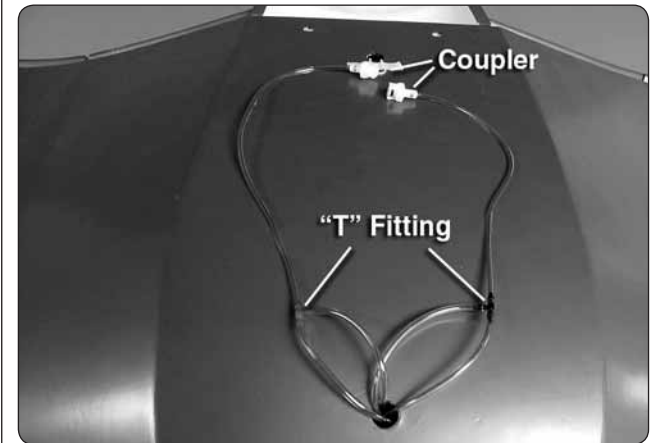

2. Cut the four air lines approximately 3" [76mm] outside of the hole in the wing. Install a "T" fitting to the two pink colored lines and a "T" fitting to the two purple lines. Install a pink and purple extension of approximately 6" [152mm] onto each of the "T"s and then install an air line coupler to the end of each line.

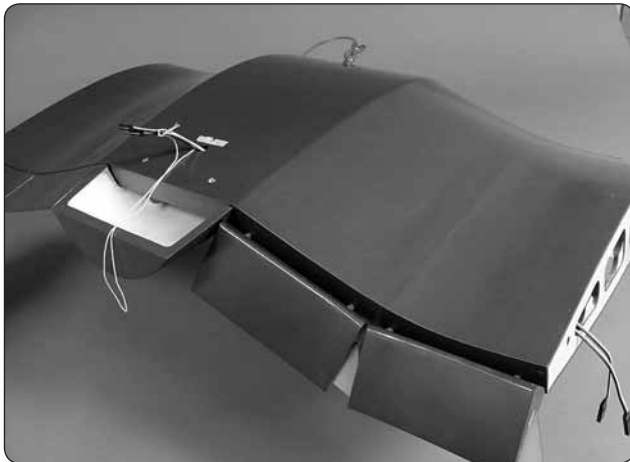
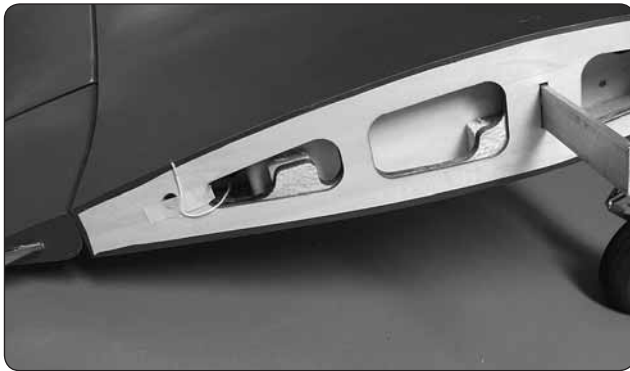
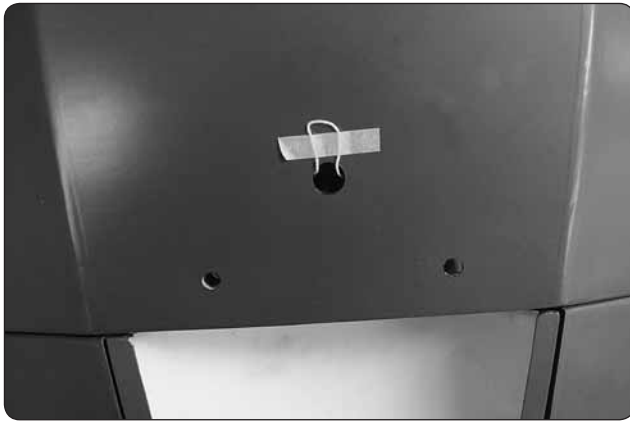

□ □ 3. On the top center rear of the wing is a hole with a string taped. The opposite end of the string is taped to the root rib of the wing. Tie two 24" [610mm] servo extensions to the string and pull them through the wing. Do this for both the left and right side of the wing.

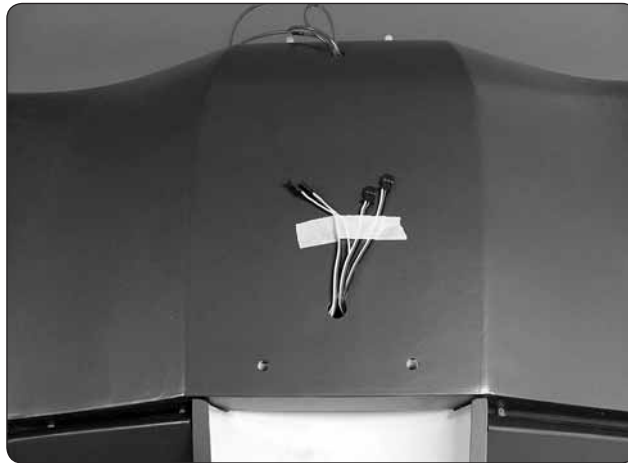

□ □ 4. Tape the leads to the wing to prevent them from dropping back into the wing.



□ □ 5. Glue a nylon pin into the forward hole in the root rib of the wing center section. The pin should extend approximately 1/2" [13 mm] from the rib. Do this on both sides of the wing center section.

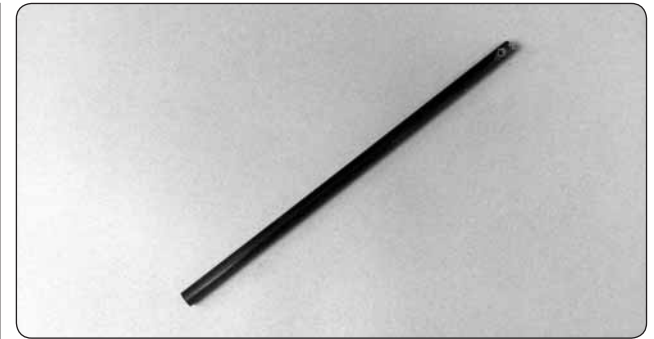

□ □ 6. Locate one of the carbon fiber tubes with a nylon insert and a pre-drilled hole in one end. The hole is pre-tapped. Insert and then remove a 4-40 × 1" [25 mm] socket head cap screw into the hole to check that the tapped hole and bolt fit well.



□ □ 7. On the top of the wing towards the trailing edge of the wing is a pre-drilled and tapped hole. Insert and then remove a 4-40 × 1" [25 mm] socket head cap screw into the hole to check that the tapped hole and bolt fit well.



□ □ 8. On the top and bottom of the wing near the center of the wing are two pre-drilled and tapped holes. Insert and then remove a 4-40 × 3/4" [19 mm] socket head cap screw into each hole to check that the tapped hole and bolt fit well.

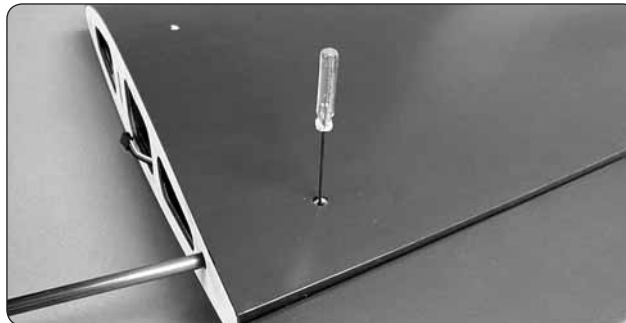
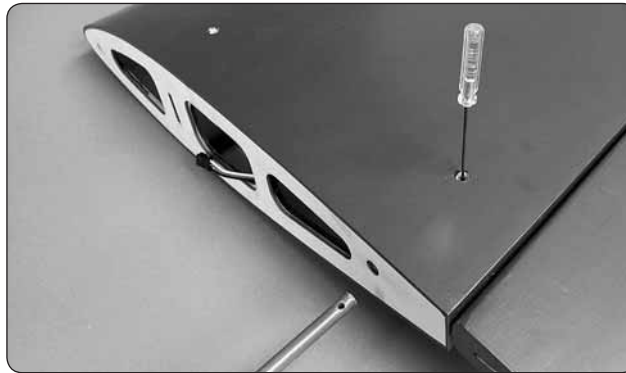

□ □ 9. In the rear hole in the top of the wing, insert a ball wrench that is small enough to fit through the hole. A 2-56 wrench works well for this. Insert the end of the carbon tube with the tapped hole into the hole, sliding it in until it contacts the wrench. Raise the wrench a little until the tube is able to be inserted further into the wing. Use the wrench to locate and align the hole in the tube with the hole in the wing.



□ □ 10. Thread the 4-40 × 1" [25 mm] socket head cap screw into the wing and through the hole in the tube. Be sure that you do not force the bolt. When the holes are

aligned properly the bolt will thread through smoothly. Leave the bolt in place for the next couple of steps.

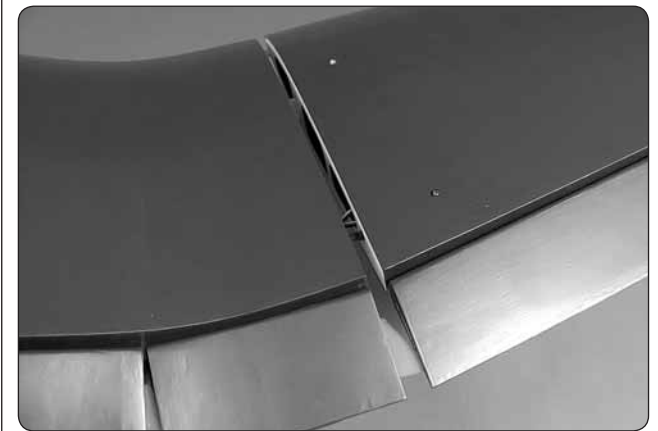
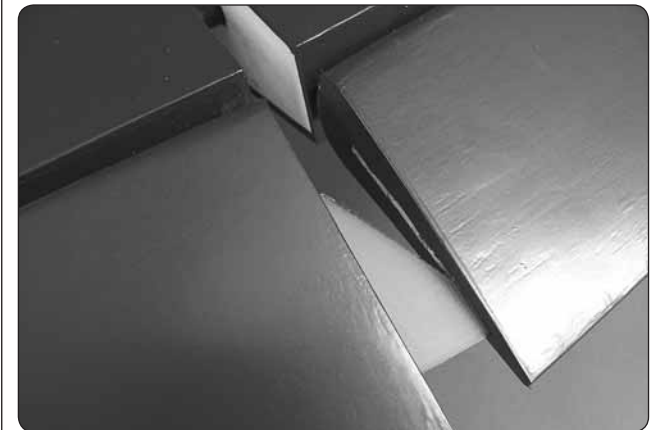
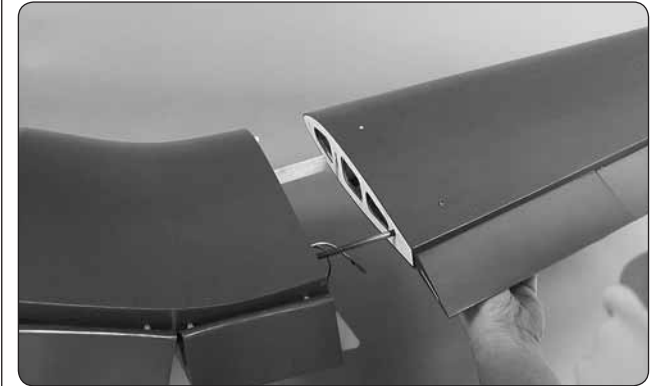

□ □ 11. Test fit the right wing panel onto the wing center section. As you slide the wing together be sure

to align the flap on the outer wing panel with the flap tab extending from the flap in the wing center section. Once you are satisfied with the fit of the wing and center section remove the outer wing panel.

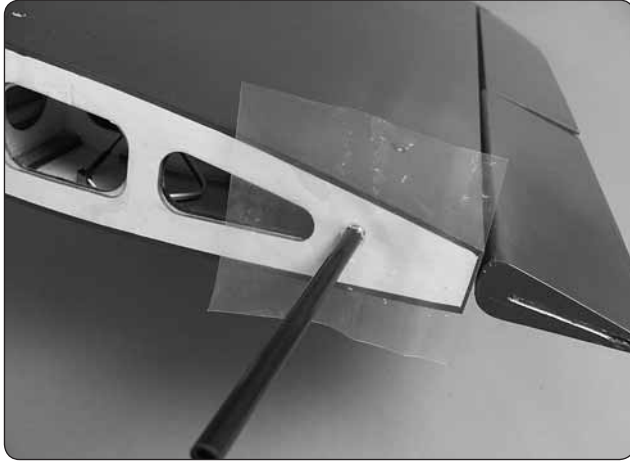

□ □ 12. Cut a 3" × 3" [76 mm × 76 mm] square from a plastic bag. Make a small hole in the center of the plastic and slide it over the carbon tube.

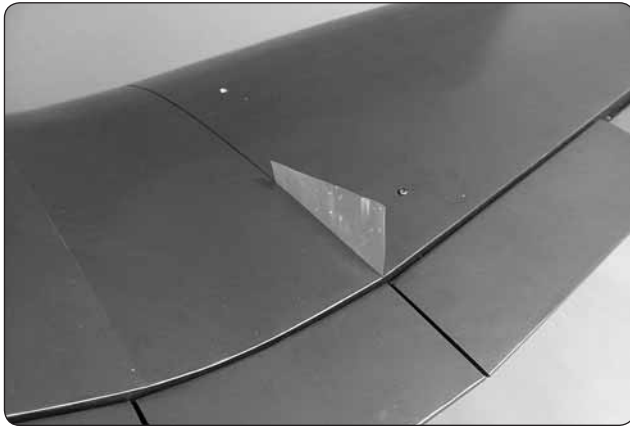

□ □ 13. Apply a light coating of epoxy to the carbon tube. Install the outer wing to the wing center section. As you slide the tube into the wing center section clear away any excess epoxy. Repeat this until the wing panels are pushed tightly together. Once the wings are together tighten the 4-40 × 3/4" [19 mm] socket head cap screw in the forward hole in the top of the wing to keep the wings securely together while the epoxy hardens.

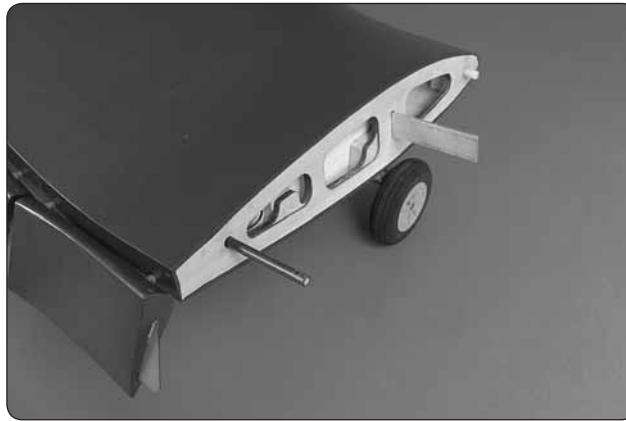

□ □ 14. Once the glue has hardened remove both of the wing bolts. Then, slide the outer wing panel from the wing center section.

□ 15. Repeat steps 1-14 for the left wing panel.



## Did You Know?...

According to old stories, the Japanese learned to call the F4U "Whistling Death" because of the high-pitched sound it made, though such a melodramatic name sounds suspiciously like an invention of American publicists. It was also known as the "Bent Wing Bird", though on the other side of the coin this name sounds more like something out of company press releases. Whatever the enemy or the aircrew actually called the F4U, it was still a machine to be reckoned with, one way or another. Many pilots became aces in the Corsair, but even its most passionate advocates admitted that it was a handful.

## ASSEMBLE THE FUSELAGE

**Note:** Just a reminder, whenever a screw is threaded into wood sheeting or wood blocks we recommend that you install the screw and then remove it. Apply a drop of thin CA glue into the hole to harden the threads. After the glue has hardened, re-install the screw.

## INSTALL THE RUDDER & STAB / ELEVATOR



□ 1. Install the threaded nylon control horn onto the threaded end of the elevator control wires.



□ 2. This next step can be a bit tedious so plan to take your time. Install a 6-32 × 1-1/2" [38 mm] socket head cap screw into the two holes in the fiberglass fairing on top of the elevator passing through and exiting from

the bottom of the stabilizer. This can be a bit difficult. We found it was easiest to do this with a forceps by grabbing the head of the bolt and feeding it down into the holes. You can also use a magnetized ball wrench or by placing a small amount of clay into the head of the bolt and inserting the ball wrench into it. If while inserting the bolt it should fall into the fiberglass fairing you can remove it through the hole in front of the fairing. Once both bolts are in place through the stab set the stab aside, making sure you do not dislodge the bolts.

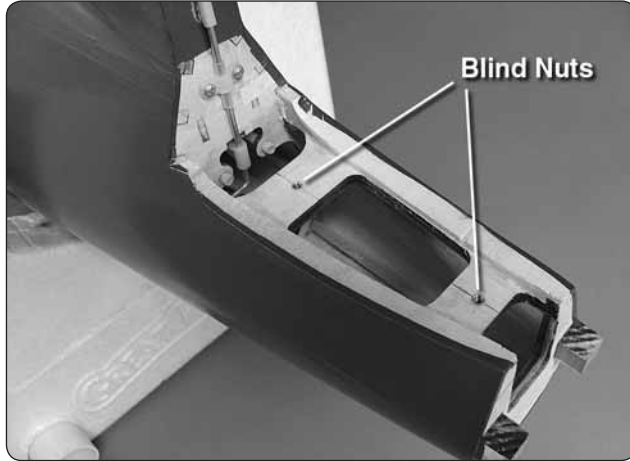

❑ 3. Next you are going to test fit the stab to the stab saddle to get a feel for the installation of the stab before applying epoxy. The back of the fuselage has two blind nuts installed in a plywood plate. The bolts in the stab will screw into these. Before fitting the stab to the fuselage be sure you have a ball wrench that is not magnetized. Using a magnetized ball wrench will likely pull the bolts out of the stab. Place the stab onto the stab saddle. Center the stab on the stab saddle. Then, use the ball wrench to find the head of the bolt and thread the bolt into the blind nuts. Now that you have a feel for the installation process remove the stab, leaving the bolts in place in the stab, and set the stab to the side.

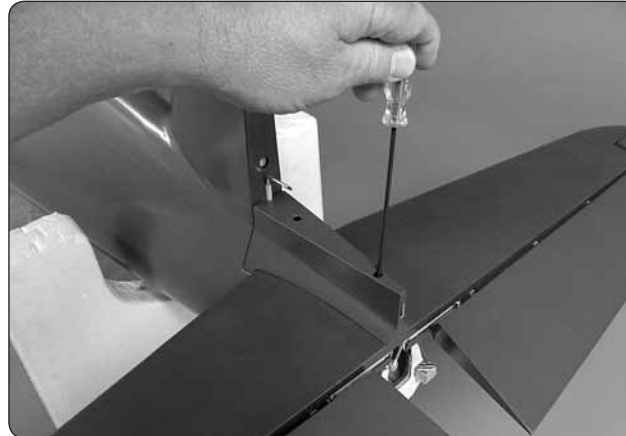
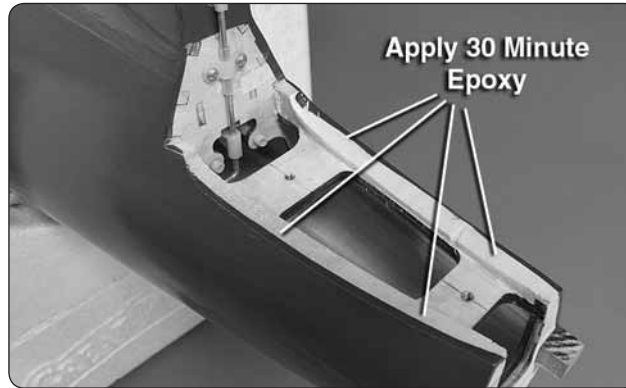

❑ 4. Apply 30 minute epoxy to the stab saddle. Install the stab onto the stab saddle and tighten the bolts securing the stab to the fuselage. Clean any excess epoxy from the fuselage and stab with a paper towel and alcohol.

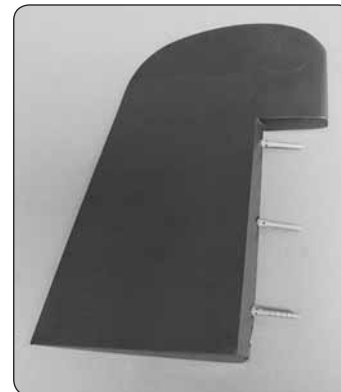

❑ 5. Apply a couple of drops of oil or Vaseline to the center of three hinge point hinges. This will prevent glue from getting into the hinge. Apply epoxy to one end of each hinge and insert them into the rudder. Once the glue has hardened move on to the next step.

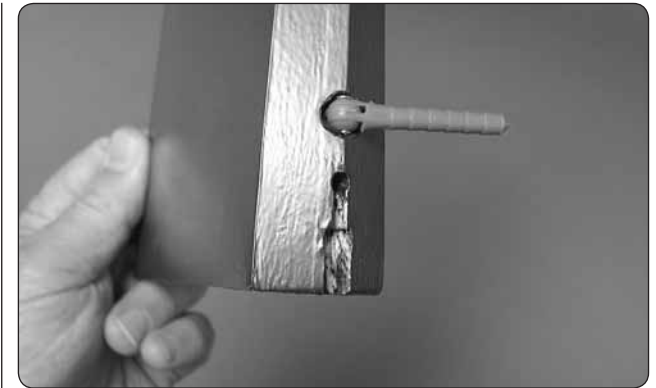

❑ 6. Apply epoxy into the small hole in the bottom of the rudder and onto the three hinges. Insert the rudder into the fin. Clean any excess epoxy away with a paper towel and alcohol. Allow the epoxy to harden.

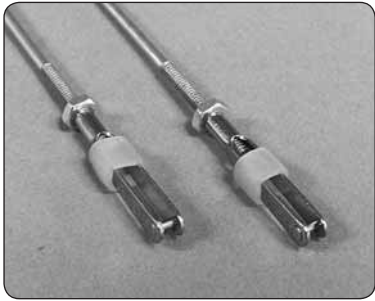

7. Prepare two 48" [1220mm] threaded pushrod wires by installing a 4-40 nut, 4-40 threaded clevis (20 turns) and silicone clevis keeper.

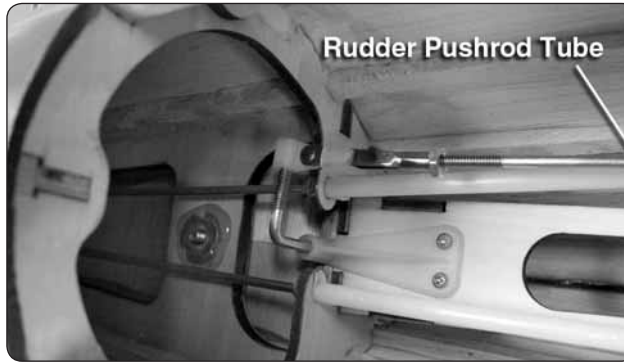

Rudder Pushrod Tube

10. Assemble another 48" [1220mm] pushrod wire, 4-40 nut, 4-40 threaded clevis and silicone clevis keeper. Insert the wire from the back of the fuselage into the nylon tube that aligns with the rudder control wire. Attach the clevis to the rudder control horn.

### INSTALL THE TAIL WHEEL ASSEMBLY

You now need to make a choice of the tail wheel that you will install. The kit includes a fixed tail wheel and we offer the option to install a Robart Fork Pneumatic Retractable Tail Wheel (ROBQ2230). If you will be installing the optional retractable tail wheel, skip ahead to "Installing the Retractable Tail Wheel". If installing the fixed tail wheel continue with the next step.

### INSTALLING THE FIXED TAIL WHEEL

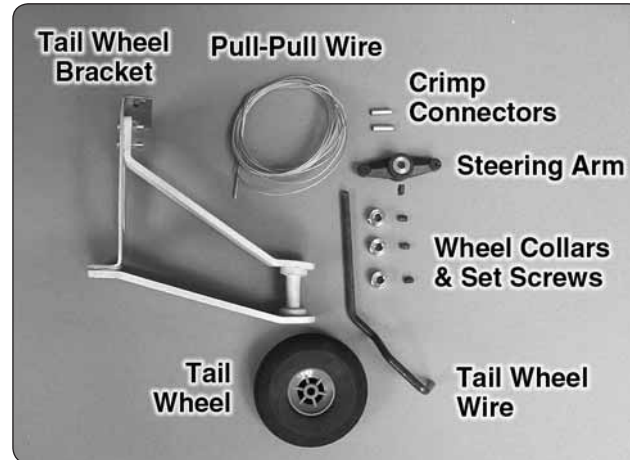

1. Locate the components of the tail wheel assembly. The tail wheel bracket, tail wheel, tail wheel wire, pull-

pull wire, (2) crimp connectors, steering arm, (3) 1/8" [3.2mm] wheel collars and (4) set screws..



Disassemble, Apply Thread Locker and Reassemble

Set Screw Goes In From Rear

2. Assemble the tail wheel assembly. As part of the process be sure to apply a couple of drops of thread locker to each of the set screws. We recommend that you disassemble the two screws and nuts from the bracket. Re-assemble them, applying thread locker.

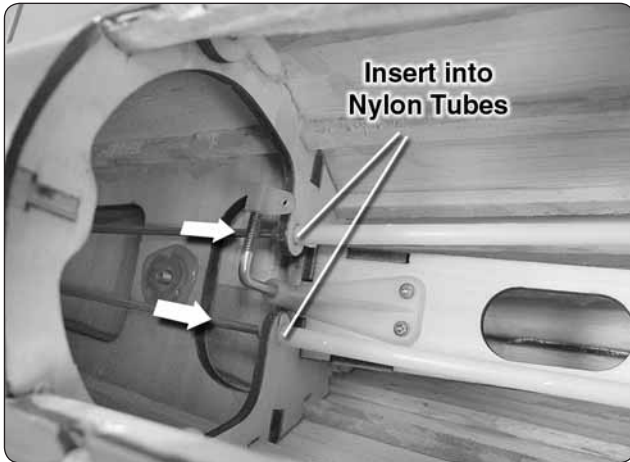

Insert into Nylon Tubes

8. From the back of the fuselage insert the two pushrod wires into the nylon tubes located in the fuselage.

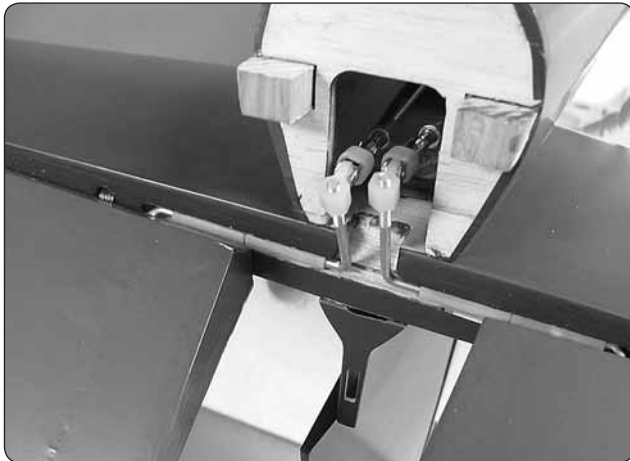

9. Attach the clevises to the elevator control horns, and secure them with silicone clevis keepers.

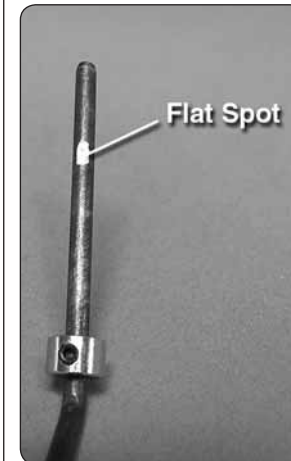

Flat Spot

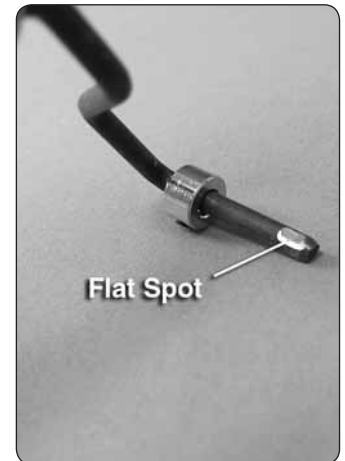

Flat Spot

3. Align the steering arm with the tail wheel wire. Then, using a small flat file or rotary tool, make a flat spot on the tail wheel wire where the steering arm set screw makes contact with the tail wheel wire and where the outer wheel collar set screw makes contact.

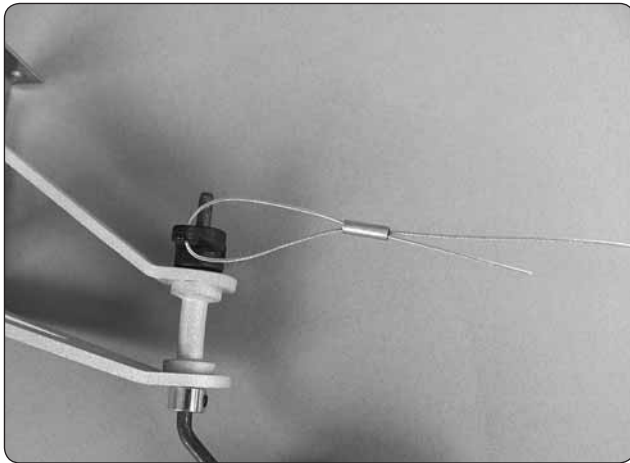

❑ 4. Use wire cutters to cut the supplied braided cable into two equal lengths. Slide a crimp connector over one end of the cables, then guide the end of the cable back through the hole in the steering arm and back through the crimp connector.

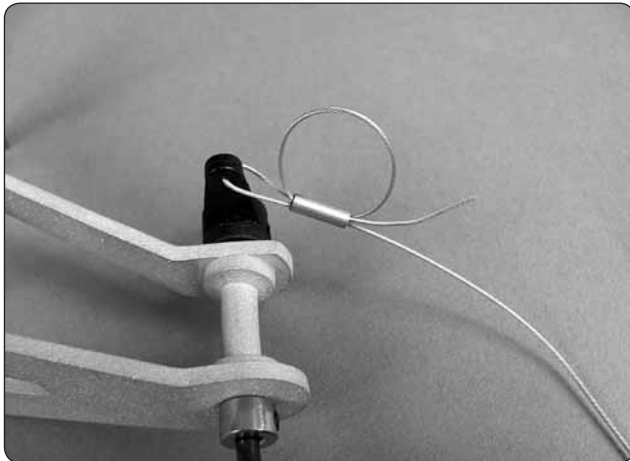

❑ 5. Wrap the cable back around the crimp connector and back through the crimp connector.

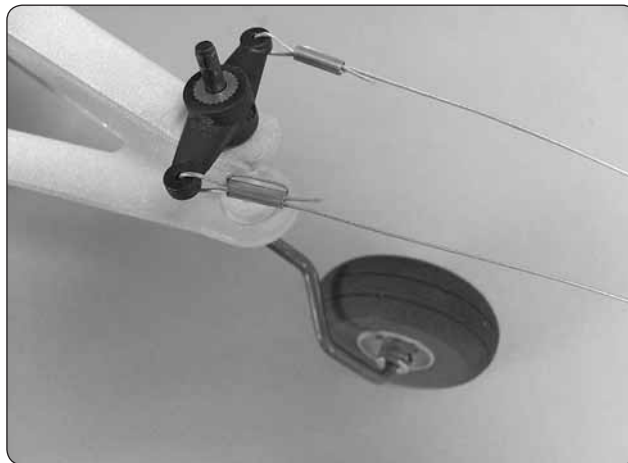
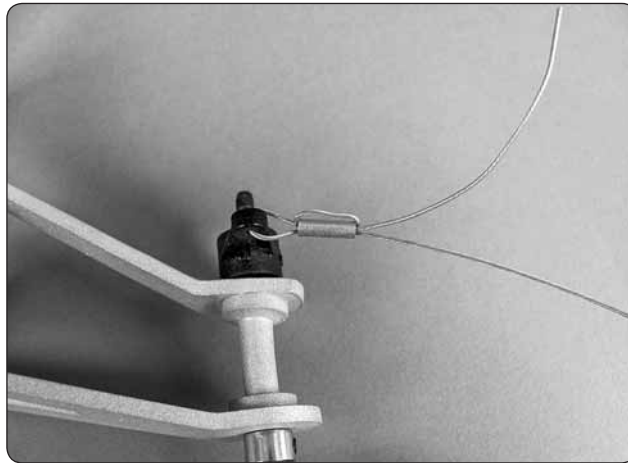

❑ 6. Use pliers to pull the cable from the first loop to reduce the size of the second loop. Squeeze the crimp connector with a pliers to keep the wire secure. Cut off the excess wire from the end.

Do this for both sides of the steering arm.



Install the Wire into the Tubes

❑ 7. Slide the wires into the plastic tubes in the back of the fuselage.



Hole Locations

❑ 8. Place the tail wheel bracket onto the wood rails. Drill a 3/32" [2.4 mm] hole through each of the mounting holes. If your drill bit is not long enough to reach the rail nearest the top of the fuselage, use medium CA to temporarily glue a 3/32" [2.4 mm] drill bit in a 1/8" [3.2 mm] brass tube. After drilling the holes, the drill bit can be removed from the tube by heating the tube. Secure the bracket with four #4 × 1/2" [13 mm] screws and #4 washers.

**Skip ahead to page 20, "INSTALL THE TAIL WHEEL DOORS".**

## INSTALLING THE RETRACTABLE TAIL WHEEL

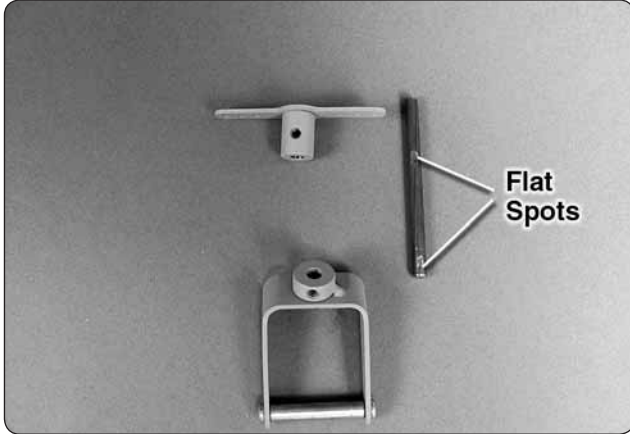
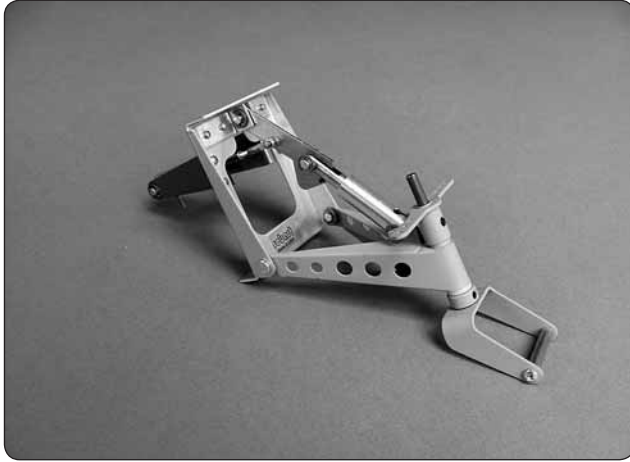

❑ 1. Remove the steering arm from the Robart retractable tail gear assembly (not included). File a flat spot near the top of the shaft for the set screw in the steering arm. Mount the steering arm to the shaft with a drop of threadlocker and the set screw. File another flat spot near the bottom of the shaft for one of the set screws in the strut. Tighten both set screws with a drop of threadlocker on each. Be certain the steering arm and the axle in the strut remain parallel with each other. Make adjustments to the flat spots if necessary.

❑ 2. Insert an 0-80 ball link ball into the outer holes of the steering arm. Secure each ball with a 0-80 nut and a drop of threadlocker.

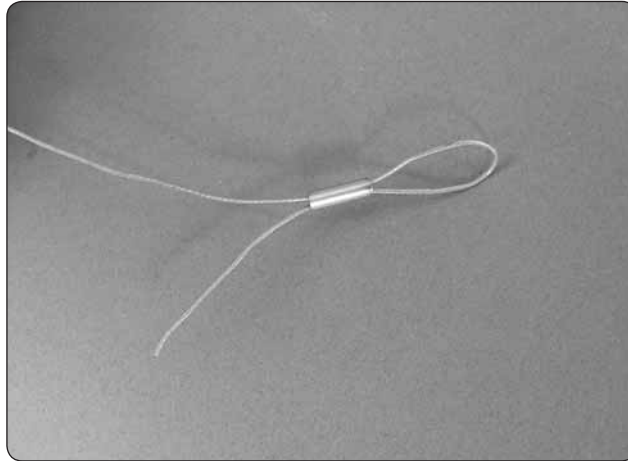

❑ 3. Use wire cutters to cut the supplied braided cable into two equal lengths. Slide a crimp connector over one end of the cables, then guide the end of the cable back through.

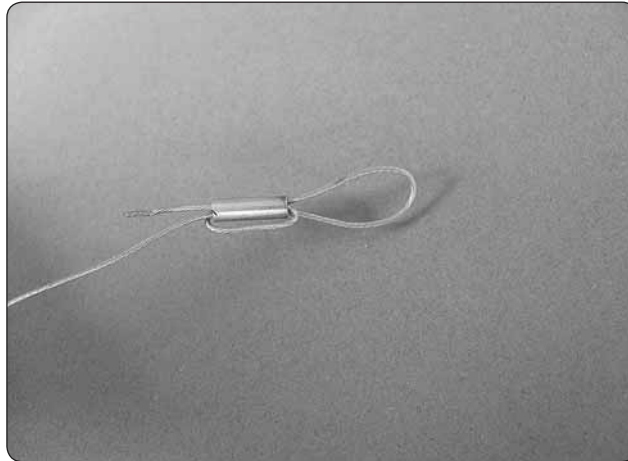

❑ 4. Wrap the cable back around the crimp connector and back through the crimp connector.

❑ 5. Use pliers to pull the cable from the first loop to reduce the size of the second loop.

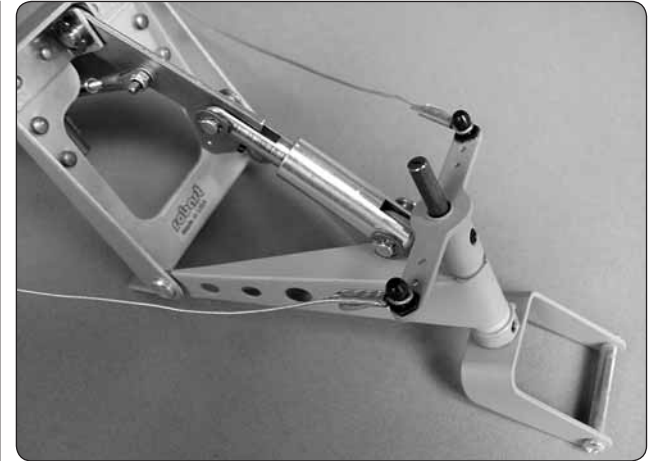

❑ 6. Now pull on the long end of the cable to reduce the size of the first loop. Slip the loop over one of the ball link balls on the steering arm. Tighten the loop until it is small enough to remain secure on the ball, yet may still be pried off. Squeeze the crimp connector with pliers. Connect the other cable to the other ball link ball the same way.

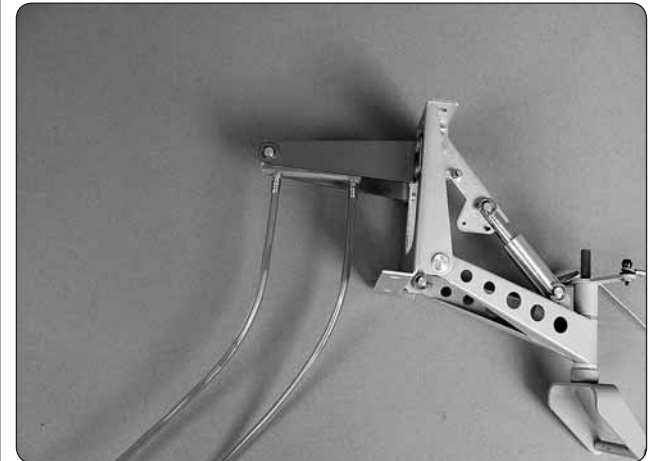

❑ 7. Connect 40" [1016mm] of purple air line to the forward air fitting and 40" [1016mm] of red air line to the aft fitting on the air cylinder. There is not enough air line leftover from the main gear, so additional line will have to be purchased separately (Robart #169 Pressure Tubing).

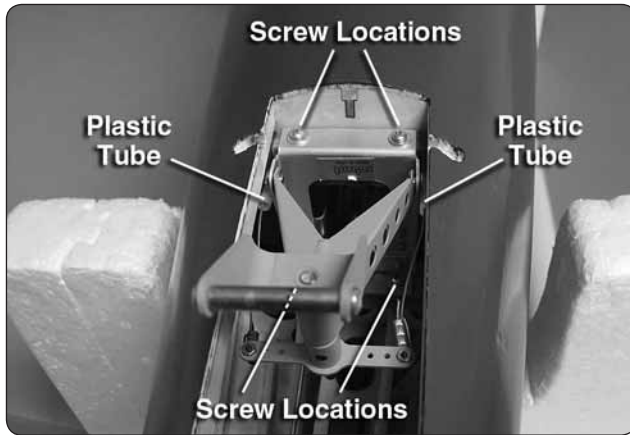

❑ 8. Place the tail gear in the fuselage while simultaneously guiding the pull/pull cable through the white plastic guide tubes. If installing the retractable tail gear, also guide the air lines through the fuselage. Drill four 3/32" [2.4mm] holes through the rails for mounting the tail gear. If your drill bit is not long enough to reach the rail nearest the top of the fuselage, use medium CA to temporarily glue a 3/32" [2.4mm] drill bit in a 1/8" [3.2mm] brass tube. After drilling the holes, the drill bit can be removed from the tube by heating the tube.



❑ 9. Mount the tail gear in the fuselage with four #4 x 1/2" [12.7mm] sheet metal screws and #4 washers. Enlarge the center hole through the 2" [51mm] tail wheel with a 3/16" [4.8mm] drill to fit the axle. Remove the axle screws. Then, slide a 3/16" [4.8mm] wheel collar onto the axle followed by the wheel and another wheel collar. Apply thread locker to the axle screws and then re-install the screws to secure the axle. (Note: There is

no need for set screws in the wheel collars. They are simply wheel spacers).

### INSTALL THE TAIL WHEEL DOORS (OPTIONAL)

We have provided tail wheel doors that will work with either the fixed landing gear or the retractable landing gear. If you fly from thick or tall grass you should consider whether you wish to install them as the grass may catch on the doors. If you choose not to install them skip ahead to the next section, *Install the Tail Cone*.



❑ 1. Locate four nylon hinges and test fit them into the holes in the landing gear door. The holes may be a little tight depending on the amount of fiberglass flashing near the holes. Use a hobby knife to open the hole as needed.



❑ 2. Test fit the doors and hinges to the fuselage. Position the doors and hinges so the doors are equally spaced. Open and close the doors, making sure they open without any restriction. Take note of the position of the hinges so when you glue them into place you will have a good idea of the hinge position.

❑ 3. Remove the doors from the fuselage and remove the hinges from the doors. Apply a drop or two of oil to the center of the hinge to prevent the glue from getting in the hinge.

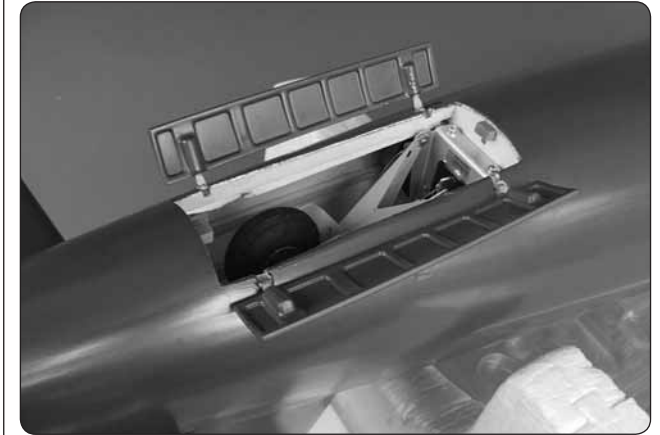

❑ 4. Using 30 minute epoxy, glue the hinges to the doors and the hinges to the fuselage. Position the doors on the hinges until the doors can be opened and closed without any restriction. Clean excess epoxy from the doors and fuselage with a paper towel and alcohol. Allow the glue to fully harden before moving on to the next step.



❑ 5. Completely open the doors and fully extend the tail wheel. Locate the 3" [76mm] spring. Insert it through the second hole from the end of the tail wheel bracket. Make a mark on the doors in line with spring. Remove the spring.

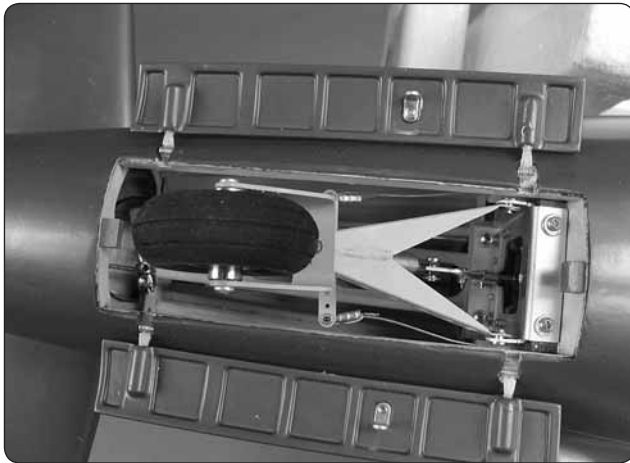

❑ 6. Locate two metal “L” brackets. Center them on the marks and glue them to the door with epoxy. Before gluing them to door, roughen the door where they will be glued and clean the “L” brackets with alcohol.



❑ 7. Pull 1/4" [6mm] of the spring from each end. Twist one end of the spring to the bracket on one of the doors. Push the opposite end of the spring through the second hole in the tail wheel bracket and twist the end of the wire through the bracket on the other door.

❑ 8. Make sure your doors open and close smoothly. Add a drop of oil to the hinges if they bind. The spring pulls the doors closed when the tail wheel is retracted and keeps them open when the gear is extended.

### INSTALL THE TAIL CONE



❑ 1. Locate the fiberglass tail cone. Test fit it to the back of the fuselage.

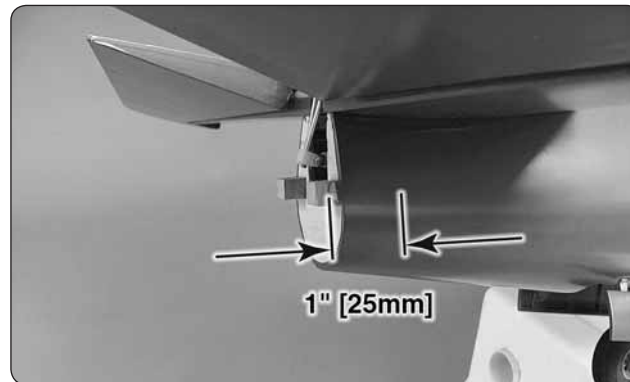

❑ 2. You will find two mounting blocks located on the back of the fuselage. The fiberglass tail cone is secured to these blocks. Measure from the center of the block

forward to the front of the fuselage 1" [25mm]. Make a mark with a fine point felt tip pen. Do this on both sides of the fuselage.

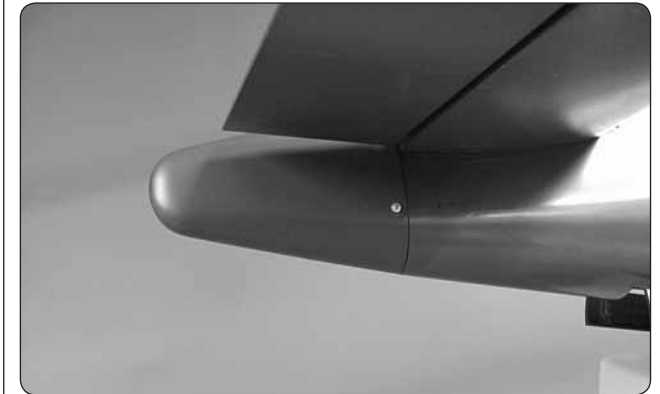

❑ 3. Place the tail cone in place on the back of the fuselage. Using your reference marks, make a mark on the tail cone where to drill the mounting holes. Drill a 1/16" [1.6mm] hole through the tail cone into the mounting blocks. Secure the tail cone with two #2 x 3/8" screws and #2 flat washers.



The most prominent gang of Marine Corsair pilots was squadron VMF-214, led by Major (later Colonel) Greg “Pappy” Boyington. Boyington was a rowdy, combative, tough, hard-drinking Marine who had flown Curtiss P-40s with Claire Chennault’s American Volunteer Group (AVG) or “Flying Tigers” in China and scored two kills. “Boyington’s Bastards” or “Black Sheep” racked up large scores against the Japanese in the South Pacific, with Boyington claiming a total of 28 kills during his combat career, 22 of them in the F4U. He was shot down and captured by the Japanese on 3 January 1944 and spent the rest of the war in a prison camp. The Japanese did not announce his capture and Boyington was presumed killed in action. He would get the Medal of Honor after his release from captivity at the end of the war.

## INSTALL THE ELEVATOR AND RUDDER SERVOS

**Note:** Just a reminder, whenever a screw is threaded into wood sheeting or wood blocks we recommend that you install the screw and then remove it. Apply a drop of thin CA glue into the hole to harden the threads. After the glue has hardened, re-install the screw.

- ❑ 1. From one of the four arm servo arms, cut three arms off leaving a single servo arm. Center the servo. Then, install the servo horn to the servo.



- ❑ 2. Using the hardware that came with your servo, install a servo into the opening in line with the elevator.



- ❑ 3. Install a 4-40 solder clevis into the outer hole of the servo arm.



Be sure the servo is centered and the elevator is centered. Make a mark on the pushrod wire where you will cut the pushrod to fit into the clevis.



❑ 4. Cut the wire on the mark you made. Solder the wire to the solder clevis using the technique described in the “Hot Tip” on page 8. After the solder has cured install a silicone clevis keeper over the clevis and install the clevis into the outer hole of the servo arm.



❑ 5. Install a servo for the other half of the elevator using the same technique used on the elevator servo you just installed.



❑ 6. From one of the four arm servo arms, cut two arms off leaving a double servo arm. Center the servo. Then, install the servo horn on the servo. Using the hardware that came with your servo, install the servo as shown. Feed the pull-pull wires from the tail wheel through the opening in the bulk head.

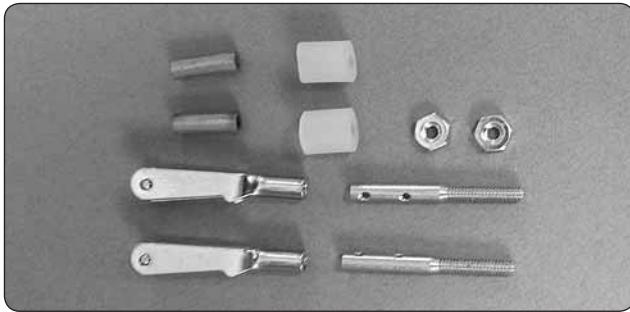

❑ 7. Locate two 2-56 threaded clevises, crimp connectors, silicone clevis connectors, 2-56 nuts and 2-56 threaded couplers. Thread a 2-56 nut and clevis onto the threaded coupler as well as the silicone clevis keeper. Be sure to apply a couple of drops of thread locker to the coupler and nut.

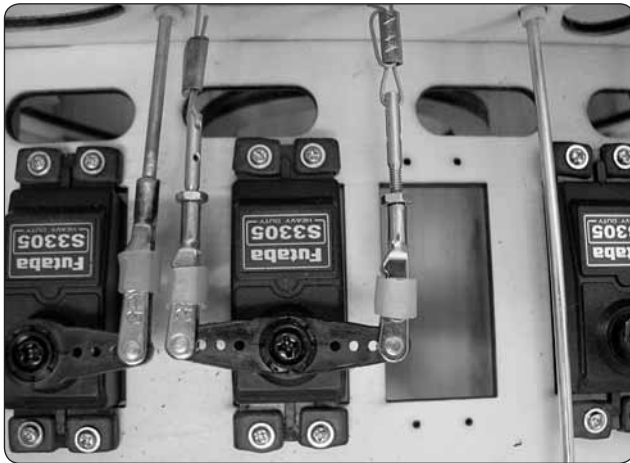

❑ 8. Slide one of the crimp connectors onto one of the tail wheel pull-pull wires and then insert the wire through the bottom hole in the threaded coupler. Attach the clevis to the control horn. Repeat this with the remaining clevis and crimp connector. Center the servo and the tail wheel. Use the same technique you used when you secured the pull-pull wires to the tail wheel, pulling the wires tight before crimping the crimp connector with a plier.

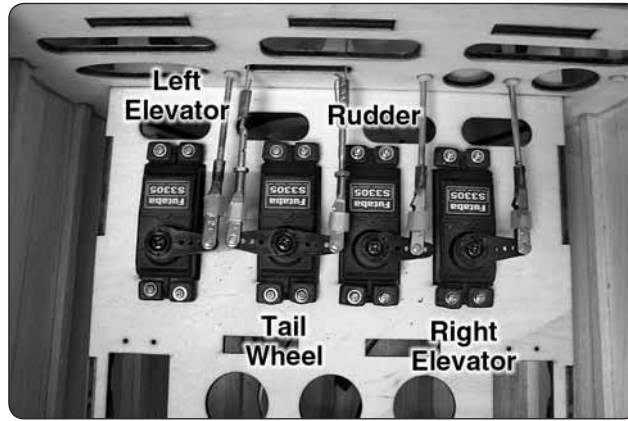

❑ 9. This is how the servo installation should look. Make sure you have put all of the clevis retainers in place and applied thread locker to the nuts.

## INSTALL THE AIR CONTROL SYSTEM

**IMPORTANT:** The next step instructs you on the installation of the air control valve servo. You will be instructed to mount it on the right side of the fuselage. It is mounted on the right side because our engine installation requires the throttle servo to be on the left side of the fuselage. Take a look at your engine and determine which side the throttle servo needs to be on. If you need to mount the throttle servo on the right side you can follow the installation instructions for the air control valve servo but install it on the left side.



❑ 1. On the right side of the fuselage install the servo that will operate the air control valve for the retractable landing gear using the hardware that came with the

servo. From the servo horn with the shortest set of arms, cut away the arms leaving a single servo arm. Enlarge the outer hole in the servo arm with a 3/32" [2.4mm] drill bit.

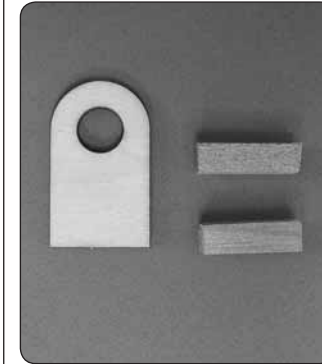

❑ 2. Locate the plywood mounting bracket for the air control valve and two 1/4" x 1/4" x 3/4" [6 mm x 6 mm x 19 mm] hardwood blocks. Glue the blocks onto both sides of the bracket.



❑ 3. Install an 0-80 ball and nut into the hole in the end of the air control valve. Be sure to apply a drop of thread locker to the threads.

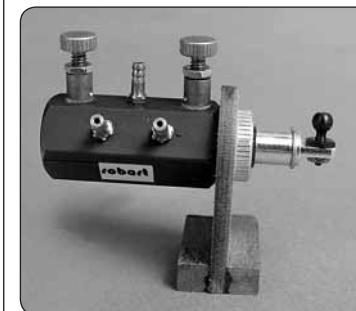

❑ 4. Secure the air control valve to the mounting bracket. Be sure to use a couple of drops of thread locker on the nut.



□ 5. From a 2-56 × 6" [152 mm] wire pushrod, cut off a portion of the threaded end of the wire leaving 1/2" [13 mm] of threads on the wire. Install a nylon ball link onto the threaded end of the wire.



□ 6. Snap the ball link onto the ball on the end of the air control valve. Position the plywood mounting bracket on the plywood former so that the pushrod wire is in line with the outer hole in the servo arm. The wire should rest on the underside of the servo arm. Glue the plywood mounting bracket to the former.



□ 7. Push the air control arm into the valve housing and rotate the servo arm forward towards the valve. Make a

mark on the wire where it passes under the hole in the end of the servo arm. Make a 90 degree bend in the wire on the mark. Cut off the excess wire 3/8" [9.5mm] above the bend. Install the wire into the servo arm and secure it with a nylon Faslink.



□ 8. Install the air tank into the hole under the servo tray.



□ 9. Locate the instrument panel and temporarily install it into the front of the cockpit.



Hold it in place and then slide the air tank into position in the support holes. You will see that the air tank makes contact with the back of the cockpit. Glue the air tank to the support formers with silicone or Shoe Goo,<sup>™</sup> leaving about 1/8" [3.2mm] of clearance between the back of the instrument panel and the bottom of the air tank. Remove the instrument panel and allow the glue to dry.

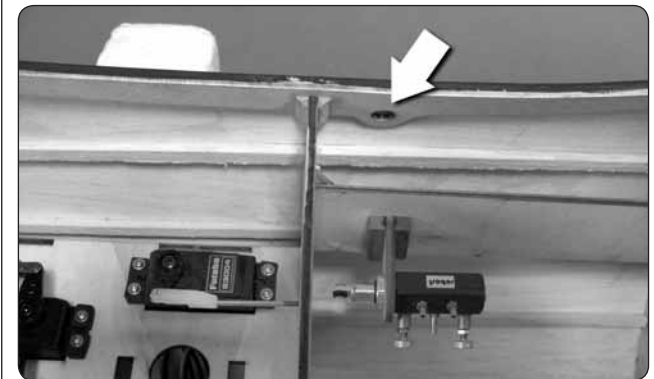

□ 10. On both the left and right side of the fuselage there is a hole that is sized to fit the air fill valve. Determine

on which side of the fuselage you would like the valve to be located and then open up the hole with a hobby knife or rotary tool.

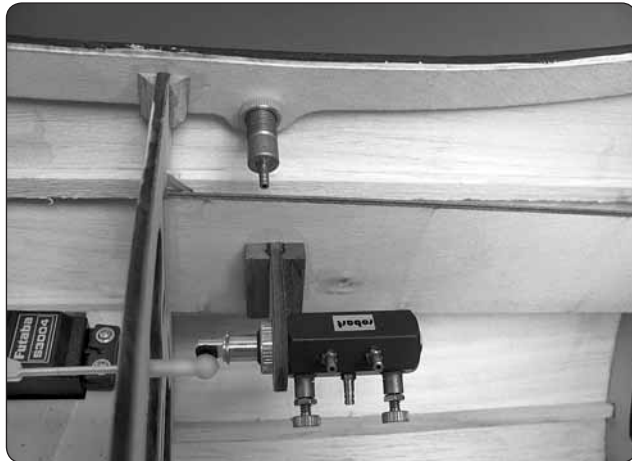

□ 11. Install the fill valve into the side of the fuselage, securing it with the nut. **Hint:** It is common to have the nut compress into the balsa wood over a period of time. This can cause the fill valve to spin loose. Find a washer that will fit over the threads of the fill valve and then tighten the nut as much as possible, compressing the balsa wood. Do this a couple of times to compress the balsa wood as much as possible. Apply a couple of drops of thread locker and then tighten the nut to the fuselage side.

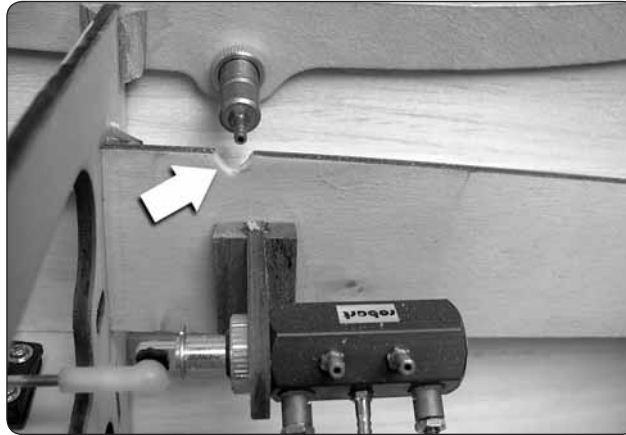
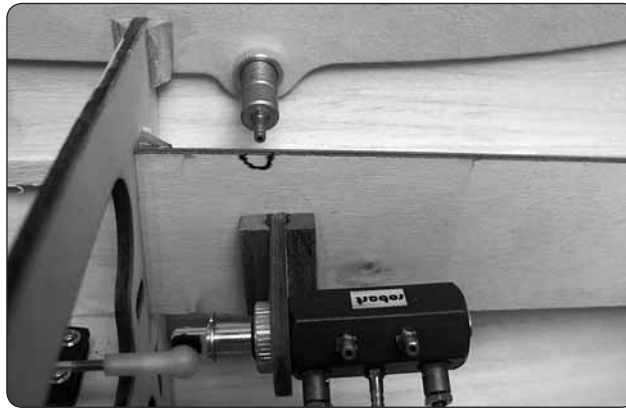

□ 12. Mark where the end of the valve gets close to the plywood former. Mark it and remove the area with a hobby knife or a rotary tool.



□ 13. Install a "T" fitting in the air line between the air tank and the air valve. Install an air line to the "T" fitting

and the air control valve. Install the air lines from the air control valve to the air couplers. If you are unfamiliar with the installation of the retractable landing gear air line system, please refer to the instructions included with the air control kit.



After working out the worst bugs, the Navy finally embraced the Corsair as the most capable fighter and fighter-bomber in its inventory, superior to the Grumman F6F-3 Hellcat. By early 1944, the Navy was making good use of the Corsair. The first Navy F4U squadron, VF-17 "Jolly Rogers" AKA "Skull & Crossbones", produced 12 aces, the most prominent being Lieutenant Ira Kepford, with 19 kills.

### INSTALL THE ENGINE, THROTTLE SERVO AND CHOKE SERVO

This manual outlines the installation of the DLE 55 engine. There are many different 50cc engines on the market that will perform well in the Corsair. If you will be installing an engine other than the DLE 55 we recommend that you take a few minutes and read through the engine installation instructions. Installation of other brand engines will be similar to the installation of the DLE 55 but you may need to modify the installation process for your particular engine. We have designed the Corsair to allow for the installation of engines with either a left side mounted carburetor or a right side mounted carburetor. For those who will be installing other engines, you may need to make your own spacers or modifications to mount the engine properly.

**Note:** Just a reminder, whenever a screw is threaded into wood sheeting or wood blocks we recommend that you install the screw and then remove it. Apply a drop of thin CA glue into the hole to harden the threads. After the glue has hardened, re-install the screw.

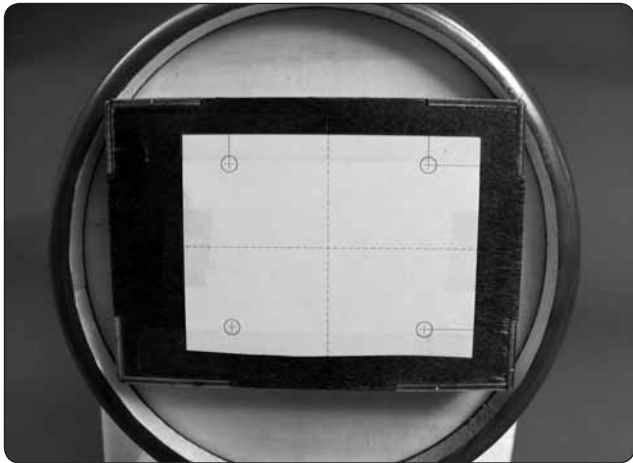

❑ 1. Cut out the paper mounting template for the DLE 55 located on page 47 of this manual. Tape the template in place on the firewall, aligning the crossing lines with the lines embossed onto the firewall.

❑ 2. Drill a 1/16" pilot hole through the paper templates. Remove the template from the firewall. Then drill 1/4" [6mm] holes through each pilot hole. Before drilling the holes check your particular brand of engine and the hardware required for mounting the engine.

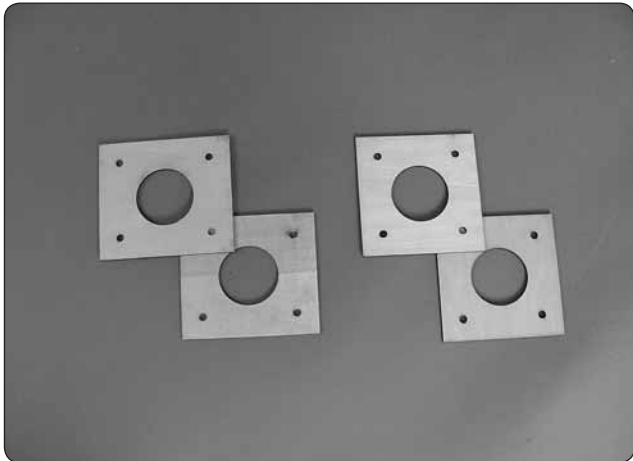

❑ 3. We have included two pairs of four plywood spacers. The firewall has been positioned so that with or without the use of spacers nearly every engine brand can be properly spaced from the firewall. Locate the spacers that match the hole pattern for the DLE 55. You will need

to use three of these spacers. The other pattern may be used for other brands. Install your mounting bolts for the stand-offs into the back side of the firewall. (We also recommend the use of 3/4" [19mm] fender washers with your mounting bolts). Install the plywood spacers over the mounting bolts. **Do not** glue the spacers to the firewall.

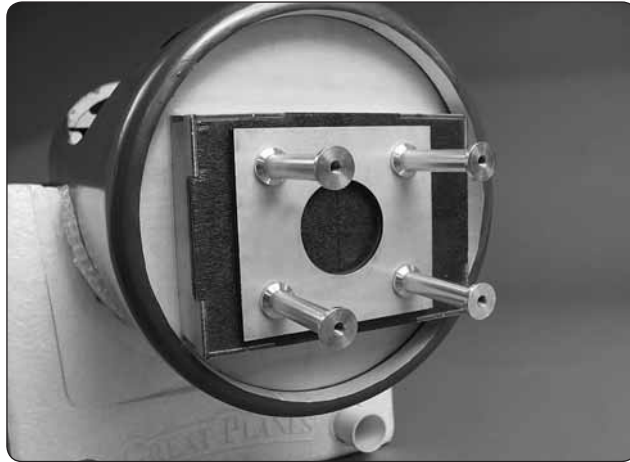

❑ 4. Hand tighten the stand-offs against the firewall. Do not do the final installation at this time. In the next few steps you will be removing the engine several times.

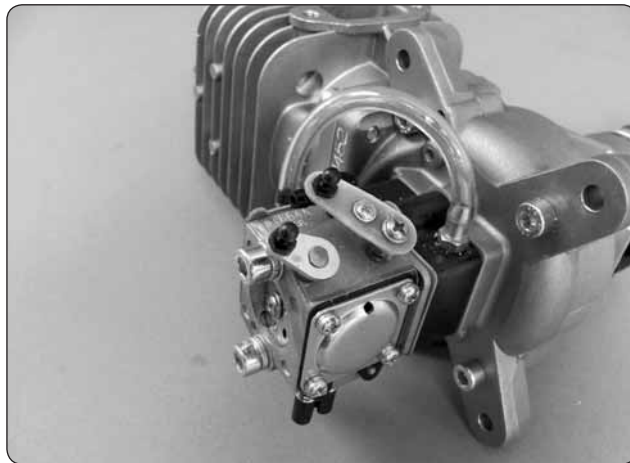

❑ 5. Install the servo arm extension onto the engine as shown in the engine assembly instructions. Install a 2-56 ball into the hole in the end of the throttle arm and secure it with a couple of drops of thread locker and a

2-56 nut. Do the same to the choke arm if you will be activating the choke with a servo. (**Note:** We will be showing the installation of a servo and linkage for the choke. We understand that many modelers have their own way of activating the choke. If you do not wish to use a servo to activate your choke, skip any references to the choke installation in the instructions that follow).

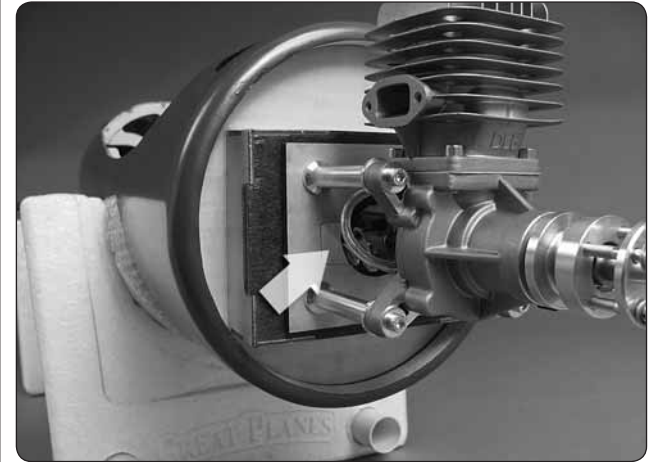

❑ 6. Temporarily mount the engine to the stand-offs. (Be sure when installing the engine that you mount it in the inverted position on the fuselage). Look at the location of both the throttle and choke arms. You need to make clearance for them in the spacers. Mark the portion of the spacer that needs to be removed. Remove the stand-offs and spacers, and then cut the area you marked from both spacers.

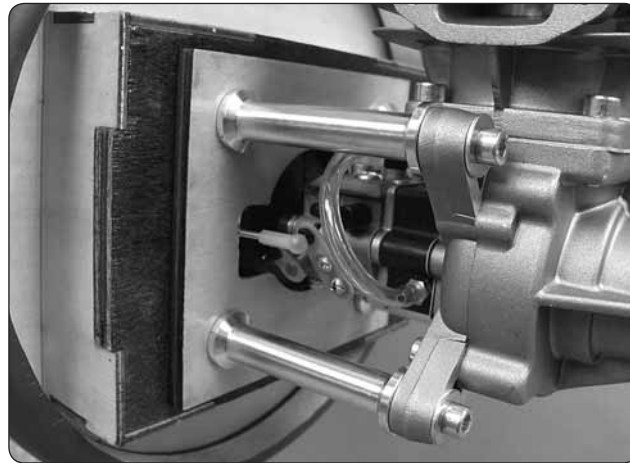
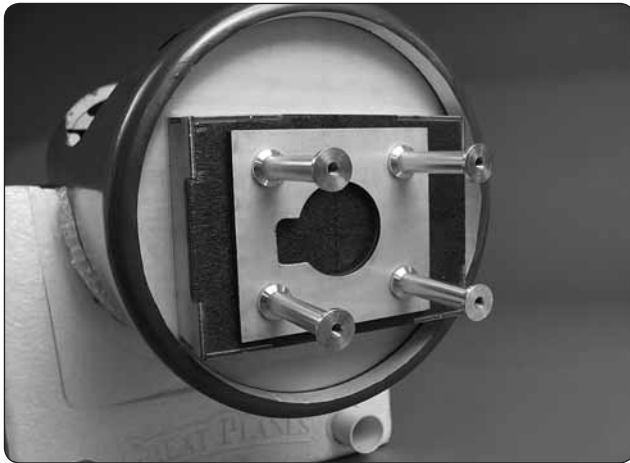

□ 7. Temporarily install the spacers and stand-offs onto the firewall. Mount the engine to the stand-offs.

□ 8. Thread a nylon ball link onto one end of a 2-56 × 1" [25mm] threaded wire. Snap the ball link onto the ball on the throttle arm. Position the wire perpendicular to the firewall and so it is in contact with the firewall. Make a mark on the firewall with a felt tip pen. Remove the engine from the stand-offs. Drill a 3/16" [4.8mm] hole through the firewall on the mark.

□ 9. Install the throttle servo into the servo tray using the hardware that came with the servo. Make a single armed servo arm and install it on the servo. Note: We have installed a plywood mini servo tray that can be glued over the standard servo opening if you wish to use a mini servo.

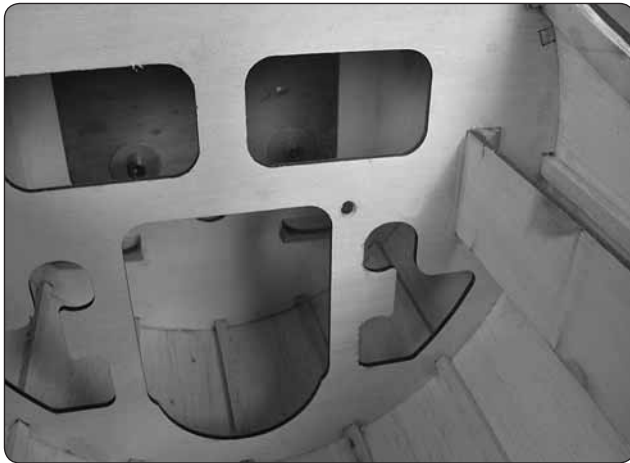

❑ 10. Locate the 12-1/2" [320mm] long tube. Insert the tube into the hole you drilled in the firewall and guide it into the fuselage. Align it with the servo arm. The tube will run into a former. Mark the spot where it contacts the former and drill a 3/16" [4.8mm] hole in the former.

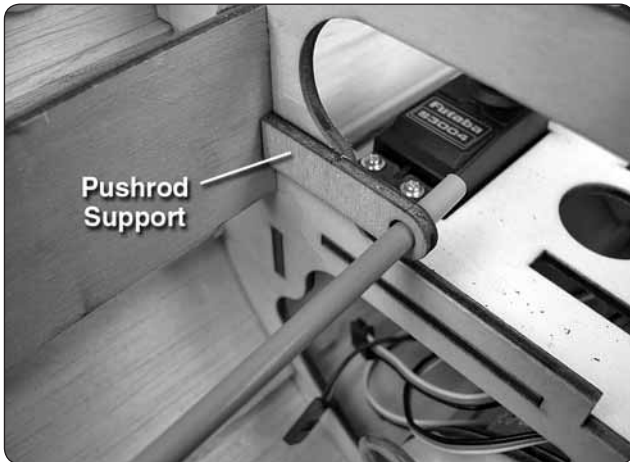

❑ 11. Slide the tube through the hole you made in the former, guiding it towards the throttle servo. Slide the plywood pushrod support over the tube. Align the tube with the outer hole in the servo arm. Then glue the support to the former. Roughen the tube where it passes through the firewall and formers before gluing the tube in place.

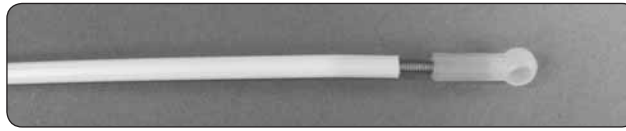

❑ 12. Thread the nylon ball link and threaded rod onto the end of the inner pushrod tube. Locate another 2-56 × 1" [25mm] threaded rod, a metal clevis, 2-56 nut and silicone clevis keeper. Thread the nut and clevis onto the wire and slide the clevis keeper onto the clevis.

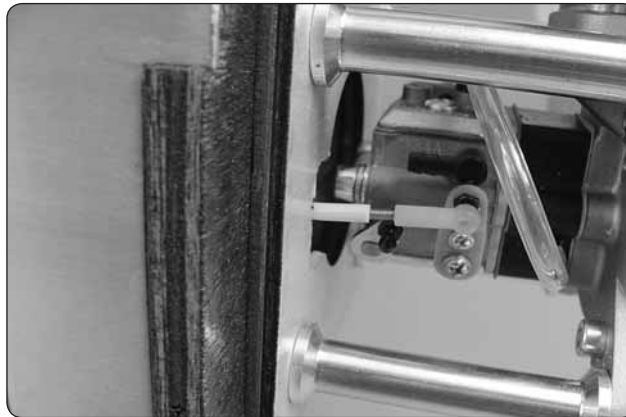

❑ 13. Temporarily slide the inner pushrod tube into the outer pushrod and snap the nylon ball link onto the ball on the throttle arm. Install the clevis into the outer hole of the throttle servo arm. Using the length of the threaded wire in the clevis, determine where to

cut off the excess pushrod from the inner pushrod tube. Remove the clevis and wire from the servo arm. Cut the inner pushrod tube and then screw the threaded wire and clevis into the tube. Re-install the clevis into the outer hole in the servo arm.

Steps 14-21 are only if you will be installing a choke servo. If you will not be doing this, skip ahead to "Install the Cowl".

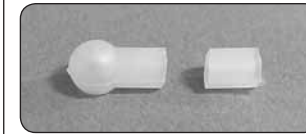

❑ 14. Cut the threaded portion of a nylon ball link in half. Thread the cut ball link onto a 2-56 × 1" [25mm] threaded rod. Snap the ball link and wire onto the ball on the choke arm. Using the same technique used for the throttle, mark where the wire contacts the firewall. Drill a 3/16" [4.8mm] hole through the firewall on the mark.

❑ 15. Locate the plywood components of the choke servo tray and two 1/4" × 1/4" × 7/8" [6 mm × 6 mm × 21 mm] hardwood blocks. Glue the servo tray together as shown.

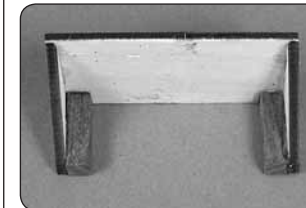
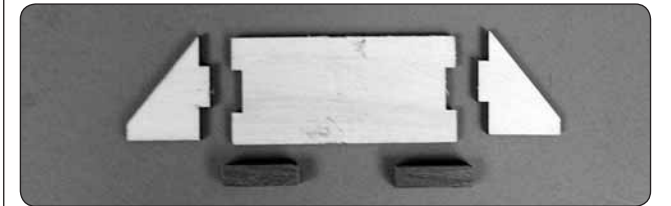

❑ 16. Install the servo into the servo tray using the hardware that came with the servo.



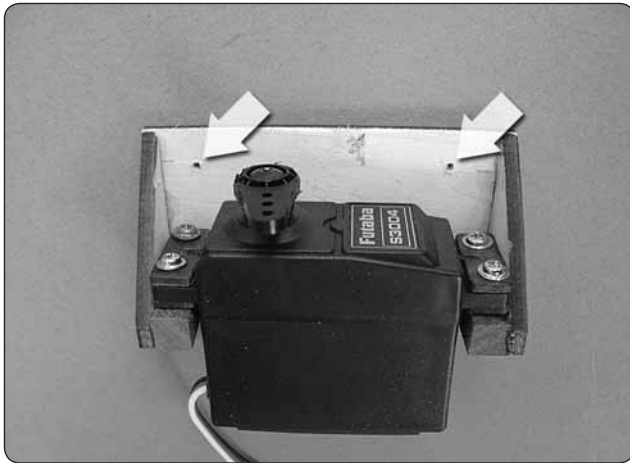

❑ 17. Drill two 1/16" [1.6mm] holes in the servo tray at the approximate locations shown.



❑ 19. Install the choke servo tray to the plywood former with two #2 × 3/8" [9.5 mm] screws and #2 flat washers. Be sure to position it so that the servo arm is in line with the pushrod tube. Cut off the excess pushrod tube. Roughen the tube where it passes through the firewall and formers. Then, glue it in place.

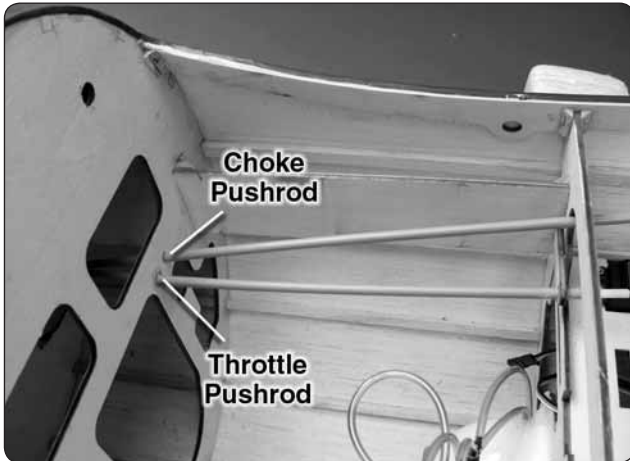

❑ 18. Just as you did with outer pushrod tube for the throttle servo, install the 6" [160mm] outer pushrod tube into the hole in the firewall, pushing it into the fuselage until it contacts the former. Drill a 3/16" [4.8mm] hole through the former. Pass the pushrod tube through this hole into the fuselage.



❑ 20. Thread the nylon ball link and threaded rod onto the end of the inner pushrod tube. Locate another 2-56 × 1" [25mm] threaded rod, a metal clevis, 2-56 nut and silicone clevis keeper. Thread the nut and clevis onto the wire and slide the clevis keeper onto the clevis.

❑ 21. Temporarily slide the inner pushrod tube into the outer pushrod and snap the nylon ball link onto the ball on the choke arm. Install the clevis into the outer hole of the choke servo arm. Using the length of

the threaded wire in the clevis, determine where to cut off the excess pushrod from the inner pushrod tube. Remove the clevis and wire from the servo arm. Cut the inner pushrod tube and then screw the threaded wire and clevis into the tube. Re-install the clevis into the outer hole in the servo arm.

## INSTALL THE COWL

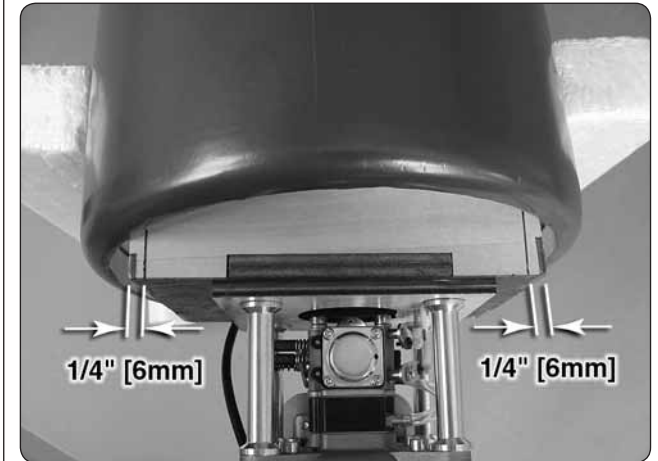

❑ 1. On the top of the firewall box make a line 1/4" [6mm] from the edge of the box.

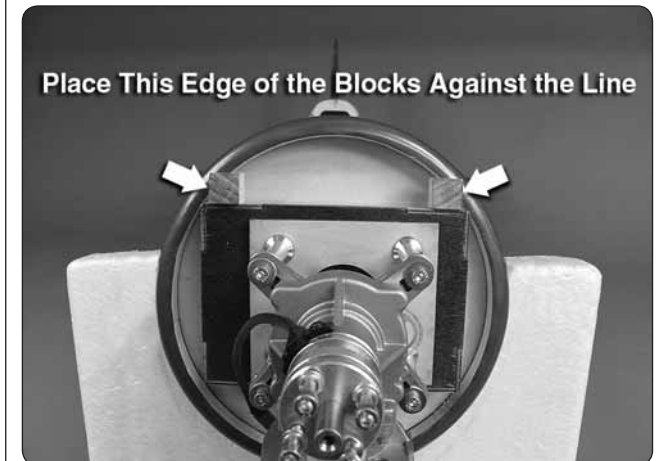

❑ 2. Locate the two 3/4" × 1" × 1" [19 × 25 × 25] hardwood blocks. Place them on the top of the firewall box aligning the edge of the blocks with the lines you drew. Trace the outline of the blocks onto the front of the fuselage.

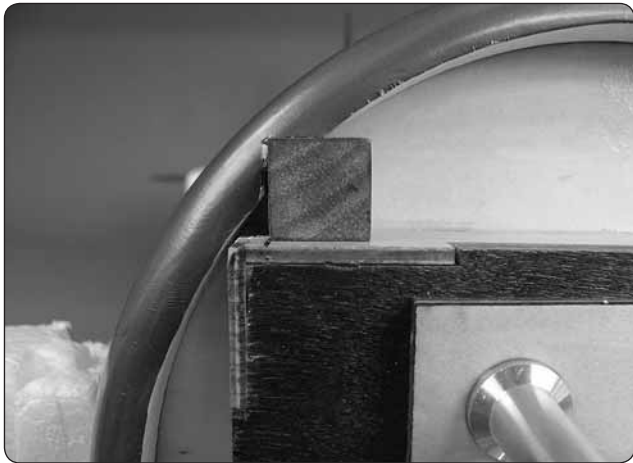

❑ 3. Cut the front of the fuselage on the lines you have drawn removing only the balsa wood. Cut the balsa, making clearance for the blocks so that they can slide into the fuselage. The blocks should slide back against the plywood ring the balsa is glued to. When the blocks are properly positioned, the distance from the front of the block to the front of the firewall box will be approximately 7/16" [11.1mm]. Take a minute to mark each block so that you know which are the right, left and bottom sides.

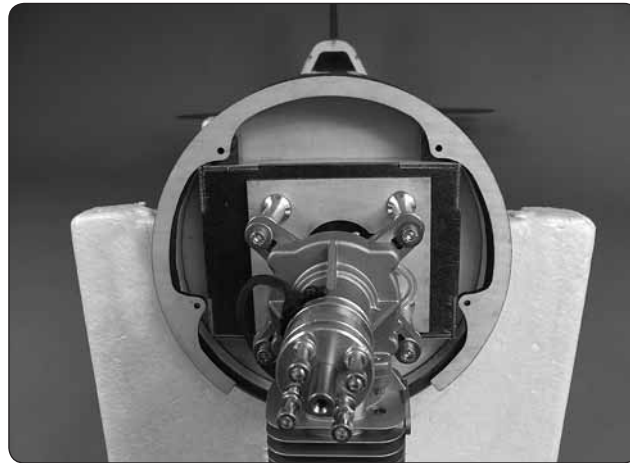
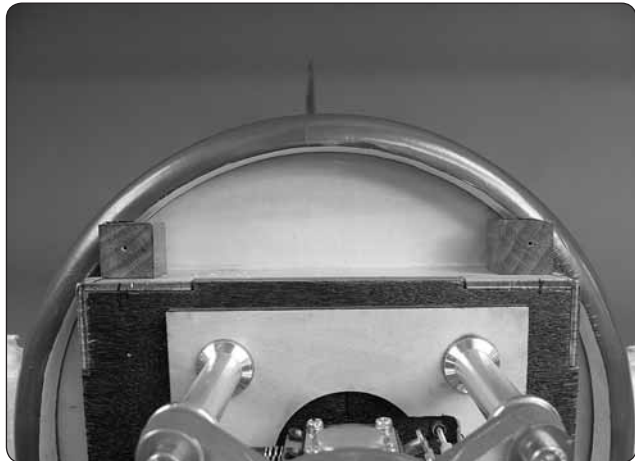

❑ 4. This step will be easiest if you have someone help you. With the two blocks in position (do not glue them yet), place the cowl ring in place on the front of the fuselage. The ring needs to be centered on the fuselage. While holding the cowl ring in place have a helper drill a 1/16" [1.6mm] pilot hole into the face of the block, making sure it is centered in the hole in the cowl ring. The hole does not have to be drilled very far into the block, just deep enough to provide a starter hole for the final drilling you will do in the next step. Do this for both blocks.

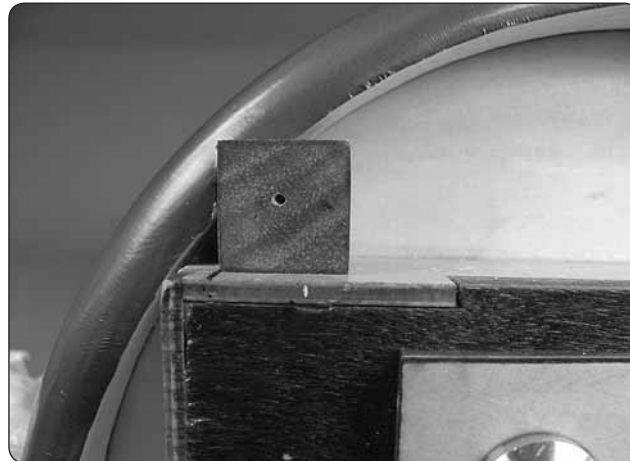

❑ 5. Remove the blocks and drill a hole through each of the blocks with a 5/32" [4mm] drill bit. It is important that the hole be drilled straight. This will be best accomplished if you can put the block in a drill press vise and drill the

hole with a drill press. If you do not have access to a drill press, be sure you are careful to drill the hole as straight as possible.

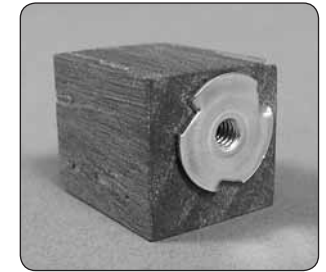

❑ 6. Install a 6-32 × 1-1/2" [38mm] socket head cap screw and #6 flat washer into the front of the hardwood block and thread a 6-32 blind nut onto the screw. Tighten the screw, pulling the blind nut into the back of the block. Do this for both blocks.

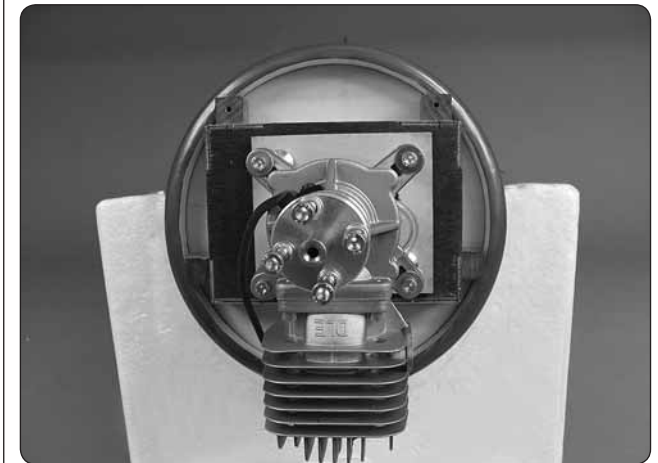

❑ 7. Place the blocks back into position on the firewall block. Locate two 5/8" × 3/4" × 1" [16mm × 19mm × 25mm] hardwood blocks. Place each of the blocks against the firewall box as shown in the photo. The block will rest against the side of the firewall box and the balsa fuselage. The block will rest in place without any glue for this step.

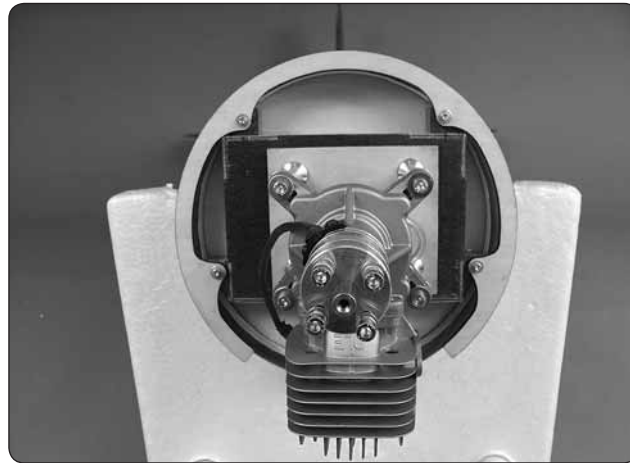
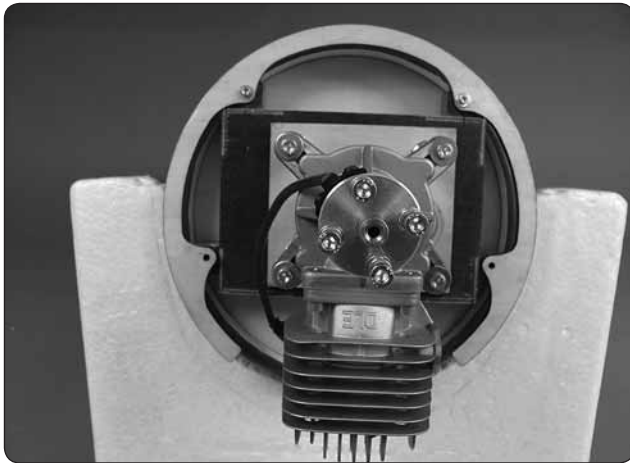

□ 11. Bolt the lower blocks to the cowl ring with two 6-32 × 1-1/2" [38 mm] socket head cap screws and #6 flat washers. Slide the ring in place and put two more bolts into the top two blocks.



□ 8. Attach the cowl ring with two 6-32 × 1-1/2" [38 mm] socket head cap screws and #6 flat washers into the top two blocks.

□ 9. Using the same procedure used on the top two blocks, drill a hole into each of the lower two blocks. Once you have the starter hole in the block, remove the cowl ring. Mark each of the lower blocks so that you can identify the left and right block.

□ 10. Remove the cowl ring. As you did with the top blocks, drill a hole through each of the blocks with a 5/32" [4mm] drill bit. Install a blind nut into each of the blocks using the same method you used for the top blocks.

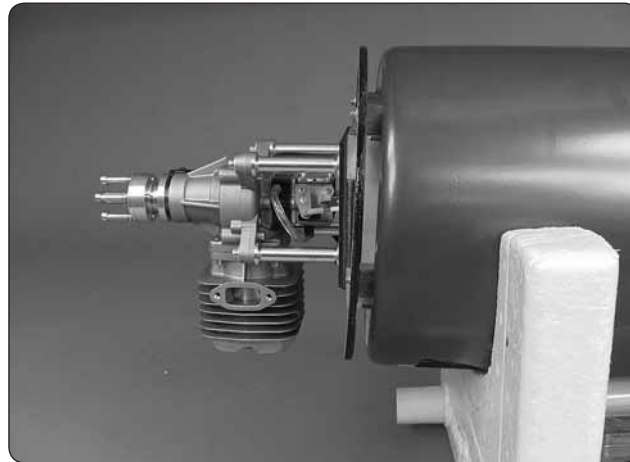

□ 12. Check the fit of all the blocks and the cowl ring. When you are satisfied with the fit of all of the components, glue the blocks to the firewall box with 30 minute epoxy. When determining the final position of the lower blocks the cowl ring should be parallel to the front of the fuselage. Allow the glue to fully harden before moving to the next step.

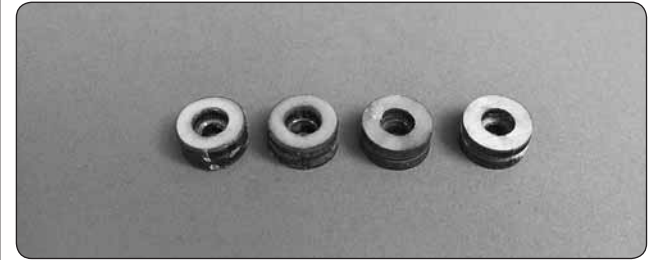
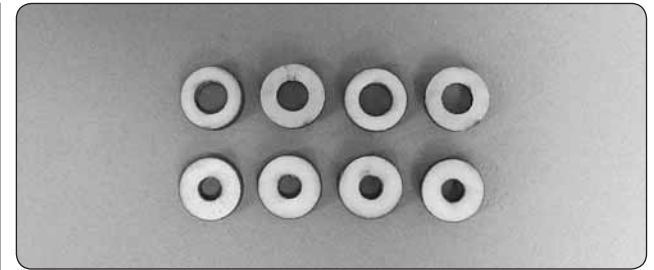

□ 13. Locate the eight plywood rings shown in the photo. There are two different diameter holes in the rings. Glue one of the rings with the small diameter hole onto the ring with the larger diameter hole. Make four sets.

□ 14. From the 1" [25mm] length of large diameter fuel tubing cut four pieces 1/8" [3mm] wide.



□ 15. Remove one of the cowl mounting bolts and washer from the cowl ring. Slide the bolt and washer through the smaller diameter hole of one of the sets of rings you made. Slide one of the 1/8" [3mm] wide pieces of fuel tubing onto the bolt. Slide the fuel tube into the large diameter hole in the ring.



❑ 18. With a fine tip felt marker trace the outline of the cylinder head onto the inside of the cowl.



❑ 19. Use a high speed rotary tool or sharp knife to roughly cut out the area you marked. Removing this area will provide the needed clearance to fit the cowl to the cowl ring. After you have removed this section of the cowl install the cowl back onto the fuselage. You should now have enough clearance around the cylinder head to allow you to position the cowl so the engine shaft is centered in the cowl. Where the cowl ring contacts the cowl, lightly sand the cowl and clean the area with alcohol. Position the cowl back on the cowl ring. Once you have the cowl centered properly, carefully reach into the front of the cowl and apply a small amount of medium CA glue to the cowl ring to tack glue the ring to the cowl. A micro tip on the end of the glue bottle will help to make the process of tack gluing the cowl easier.

Use CA accelerator to quickly harden the glue. After the glue has hardened remove the cowl from the fuselage.

**A note about the cowl mounting screws.** You have probably already noticed that with the silicone tubing sandwiched between the plywood rings, the socket head cap screws remain in place with the cowl ring. This will be important and a great help to you when you mount the cowl to the front of the fuselage once the dummy engine is in place. For the rest of the cowl installation you should always have the cowl mounting screws retained in the cowl ring with approximately 1/2" [13mm] of the threads sticking out from the back of the cowl ring.

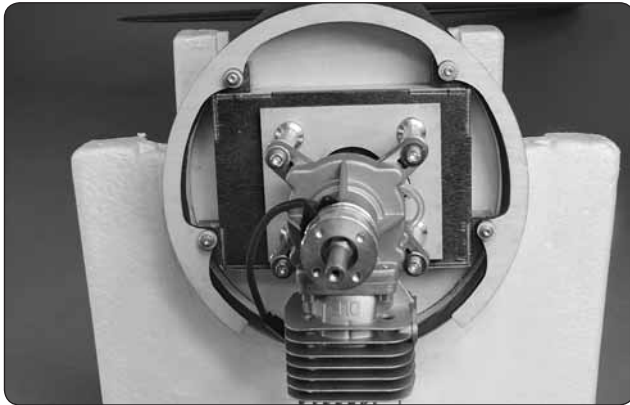

❑ 16. Apply glue to the back of the ring. Install the bolt back into the cowl ring. Tighten the bolt so the ring tightens against the cowl ring, gluing the ring to the cowl ring. Do this for all four rings.

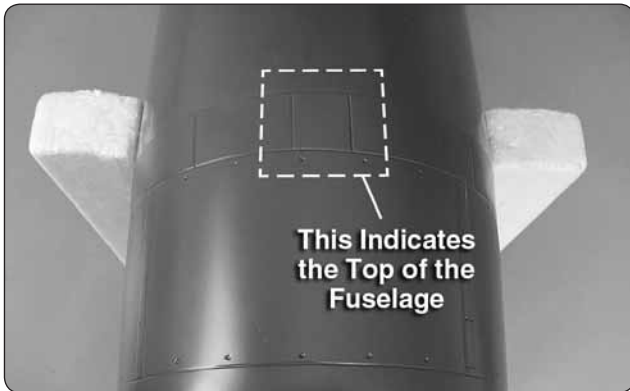

❑ 17. Position the cowl on the cowl ring so that the small cowl flap is centered on the fuselage.

#### Top Center of the Dummy Engine

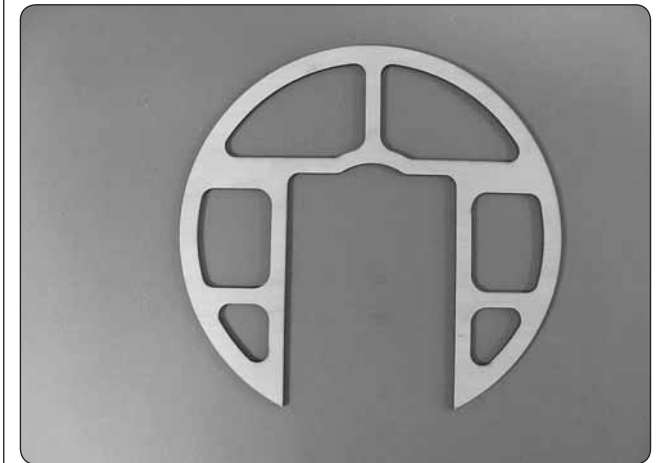

❑ 20. Locate the plastic dummy engine and the plywood dummy engine former.

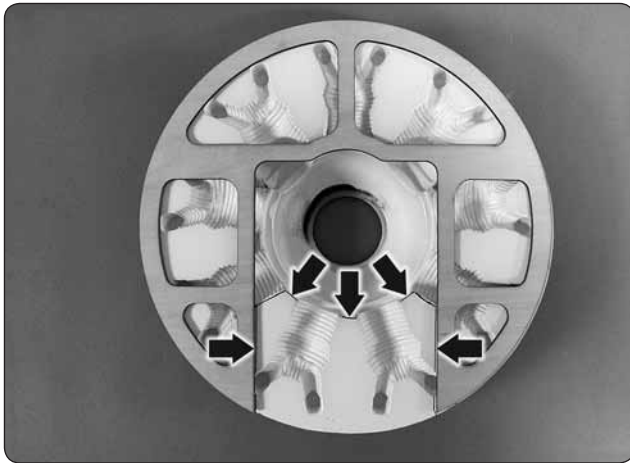

□ 21. Place the former on the back of the dummy engine. Pay close attention to the placement so that the top of the dummy engine is on the top of the former. Trace the former onto the back of the dummy engine with a fine tip felt marker.



□ 22. Remove the area you marked from the dummy engine.



□ 23. Place the former back onto the backside of the dummy engine. Then, trace the shapes shown onto the back of the dummy engine.



□ 24. Remove the areas that you drew onto the back of the dummy engine.

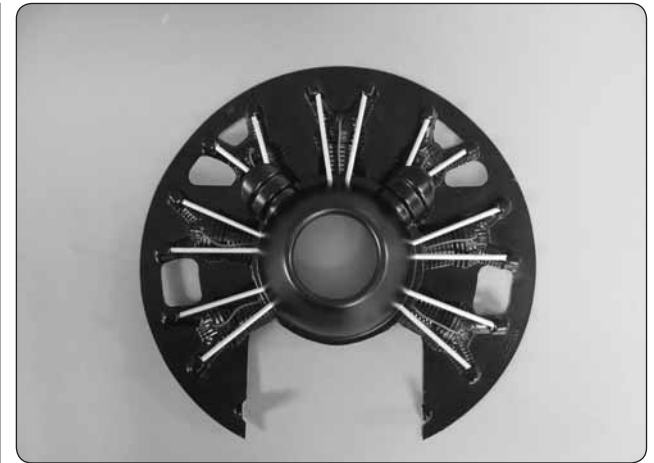

□ 25. To add some additional details to the dummy engine, drill a 1/8" [3mm] hole into each of the rockers and the cylinder base. Insert an aluminum tube into each of the holes. Drill a 1/16" [1.6mm] hole in the center of the cylinder and the base of the cylinder. Cut 2" lengths of red wire and insert them into the holes.



□ 26. On the back of the dummy engine apply a small amount of epoxy to each end of the tubes and the wires to keep them secure.

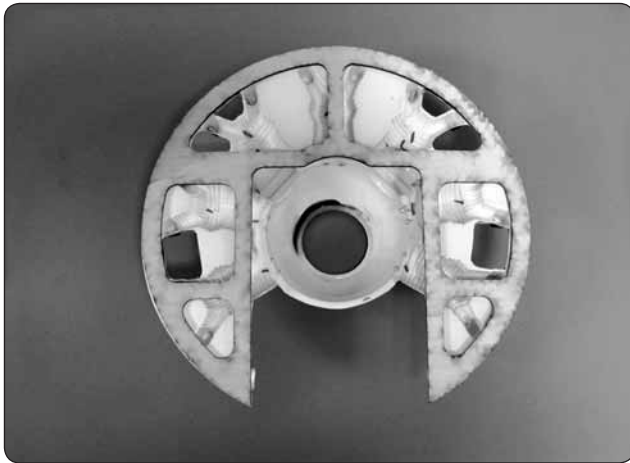

❑ 27. Glue the former onto the back side of the dummy engine.

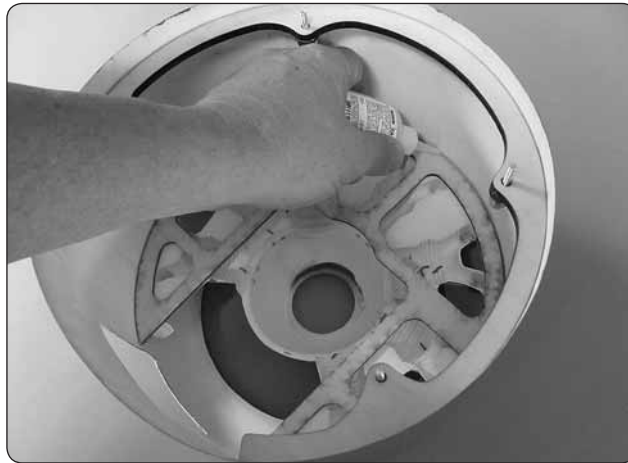

❑ 29. Adjust the position of the dummy engine until it is centered properly in the cowl. The dummy engine should fit snug and remain where you position it. When you are satisfied with the fit of the dummy engine **CAREFULLY** loosen all of the cowl mounting screws and remove the cowl, making sure you do not disturb the positioning of the dummy engine. (If your dummy engine is not tight enough to remain where you place it in the cowl, apply a couple of drops of medium CA where the dummy engine contacts the cowl to keep it in place while removing the cowl). Once you have the cowl removed, tack glue the dummy engine to the cowl ring with medium CA glue. Allow the glue to harden.

❑ 30. Re-install the cowl. Double check the positioning of the cowl and the dummy engine, making sure you are satisfied before permanently gluing everything in place in the next step. When you are satisfied remove the cowl from the fuselage.

❑ 31. To permanently attach everything to the cowl you will be applying RTV silicone glue to the front side of the cowl ring and to the back side of the dummy engine former. Clean the inside of the cowl in these areas with alcohol.

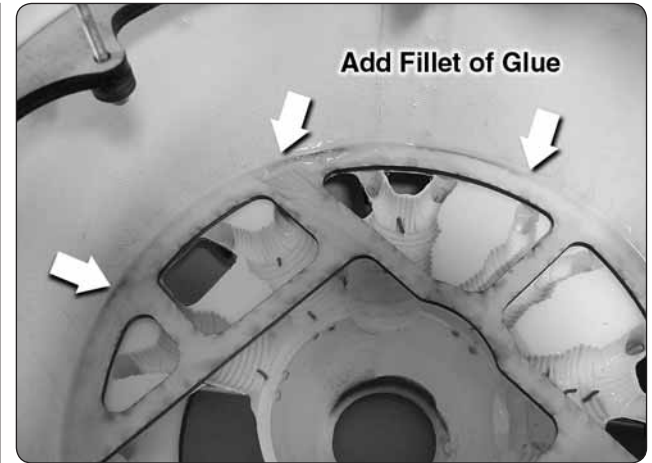

❑ 32. Apply RTV silicone glue to the dummy engine former. Use a small knife or wooden popsicle stick to apply a fillet of glue to the back of the dummy engine former.

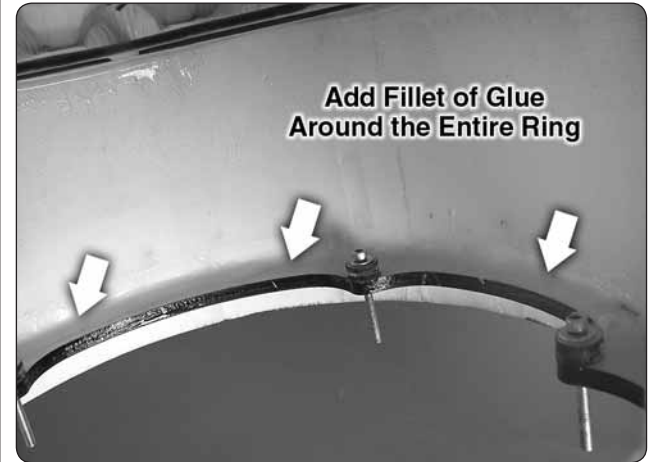

❑ 33. Apply RTV silicone glue and make a fillet of the glue on the front side of the cowl mounting ring. You should also apply a fillet of glue on the back side of the cowl ring but **do not apply glue in the area where the cowl mounting ring will make contact with the wood cowl mounting blocks**. Set the cowl aside and allow the glue to completely cure before moving onto the next step.



❑ 28. Slide the dummy engine into the back of the cowl, positioning it in the approximate place in the cowl. Install the cowl to the fuselage with the socket head cap screws that have been retained in the cowl ring. Adjust the dummy engine as needed to get it close to the proper position in the cowl. Through the cut-outs you made in the dummy engine you should be able to reach all of the screws with a long handled ball wrench. (If you do not have a long handled wrench you can get a complete set of the Great Planes® long handle ball wrenches (GPMR8008) from your hobby dealer or hobby mail order company). Tighten the cowl to the fuselage.



❑ 34. Temporarily mount the muffler to the engine. We have recommended the J'tec Radiowave wrap-around Pitts muffler (JTCG1035) for installation in the Corsair. This muffler fits without making any modifications to the fuselage. If you are using a different brand of muffler you may need to modify the front of the fuselage for it to fit. Make any modifications as needed.



❑ 35. Cut away the cowling as needed to allow the cowl to slide onto the fuselage and clear the muffler and spark plug. This would be a good time to make any final adjustments to the rough opening you made in the bottom of the cowl. Re-install the cowl to be sure you are satisfied with all of the clearances you have made. Once you are, remove the cowl.

## INSTALL THE FUEL TANK AND IGNITION MODULE

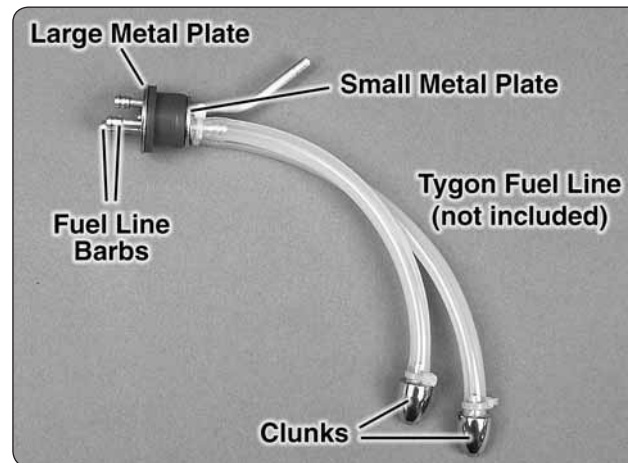
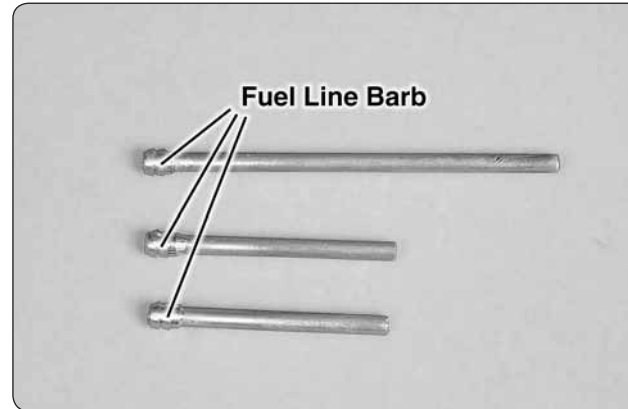

❑ 1. Assemble the fuel tank stopper assembly with the fuel tubes as shown. The easiest way is to first solder a fuel line barb onto **one** end of all three tubes. Insert the tubes into the stopper with the metal plates, and then solder a barb onto the other end of the two short tubes. Bend the vent tube and connect the pickup and fueling/defueling lines (not included) to the short tubes. Connect the clunks to the Tygon Fuel lines (not included) and secure the lines to the clunk and brass tubing with the included small tie straps.

❑ 2. Install the fuel tank stopper assembly in the fuel tank. Check that the clunks move around freely in the fuel tank. Tighten the fuel tank stopper screw. Be sure to mark which line is the vent, fill and carburetor.

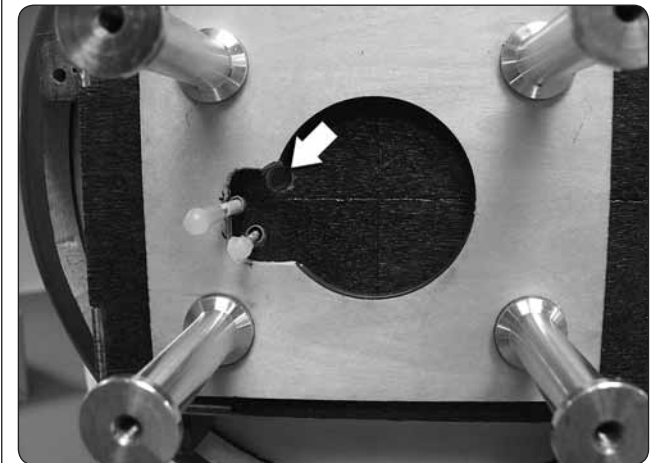

❑ 3. With your muffler mounted to the engine, use your muffler as a reference and drill two holes on either side of the muffler into the bottom of the firewall box. Be sure you position the holes so the lines will not contact the muffler. The holes will be for the vent and fill lines. Look at the fuel inlet on the carburetor. Determine a location to drill the hole for the fuel line to the carburetor. Once you determine the location where the holes can be drilled it will be easiest to drill the holes if you remove the engine from the stand-offs. Measure the diameter of your fuel tubing to determine the size holes you need to drill. Drill a hole in the firewall box for the fuel line. Drill holes in the bottom of the firewall box and the bottom of the fuselage for the vent and fill lines.

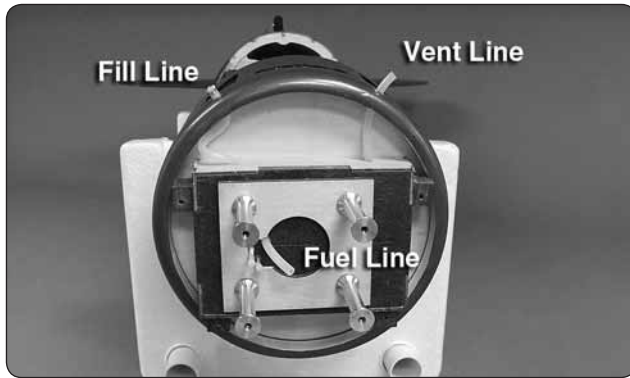

❑ 4. To install the fuel lines you will need three lengths of 12" [305mm] fuel tubing. These will be trimmed to length after the fuel tank is in place. Insert a line from outside of the fuselage through the holes you drilled and guide them inside of the fuselage as shown.

❑ 5. Pull the lines into the fuselage. Install the lines onto the proper fittings on the fuel tank. Once the lines are all connected pull the lines back through the fuselage and slide the fuel tank into position in the front of the fuselage. Do not cut off the excess length of fuel tubing yet.

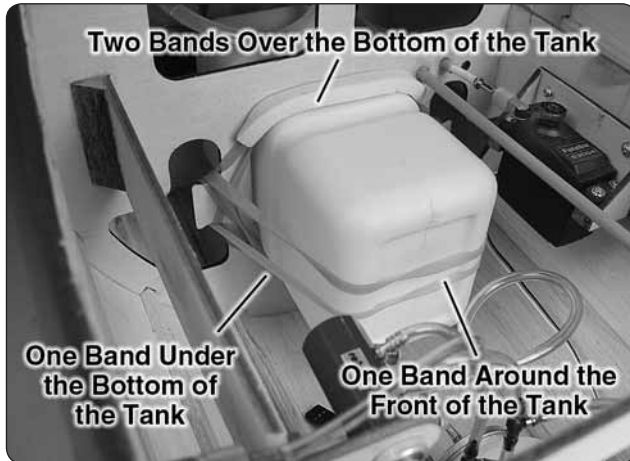

❑ 6. Once the fuel tank is resting in the cradle, place a piece of foam on the bottom of the tank. Secure the tank with four #64 rubber bands. Two of the rubber bands should wrap over the top of the tank, one rubber band over the bottom of the tank and one rubber band around the tank.

❑ 7. Trim the excess fuel line from the vent and fill lines. Re-install the engine onto the stand-offs. This is the last time that you will remove the engine so when you install it be sure to use thread locker on the bolts. Cut the fuel line to length and slide it onto the fuel intake on the carburetor. Install the aluminum fuel plug in the fill line.

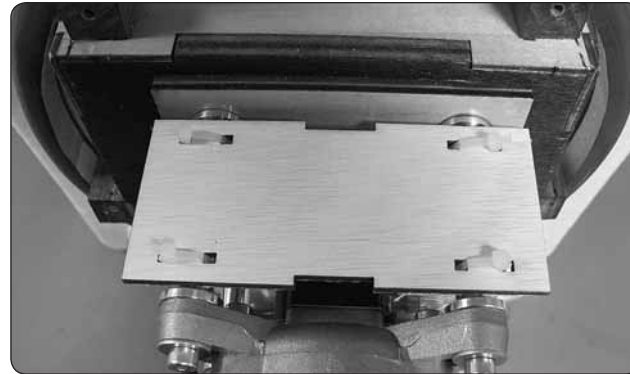
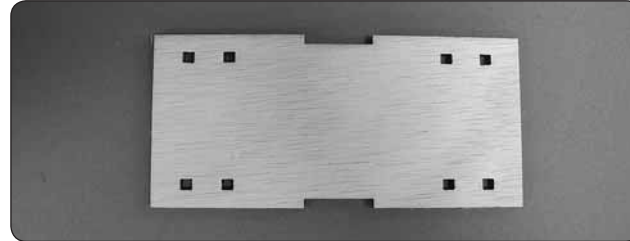

❑ 8. Locate the plywood accessory tray. Attach it to the aluminum engine stand-offs with four plastic tie wraps.

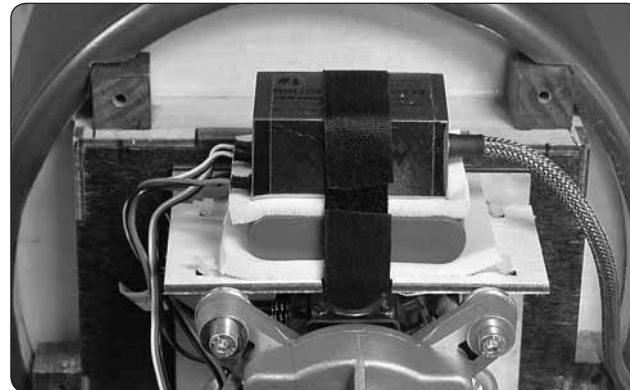

❑ 9. Install the ignition battery and ignition module with foam onto the accessory tray. Hold them in place with the Velcro® straps.

The next few steps refer to the installation of the ignition switch and charge jack. The installation will require that you glue the components to the fuselage. We chose to do it this way to maintain as scale an appearance as we could. We recommend you read through these steps to become familiar with our method. Some of you may wish to use an alternative method not requiring the permanent installation of the components.

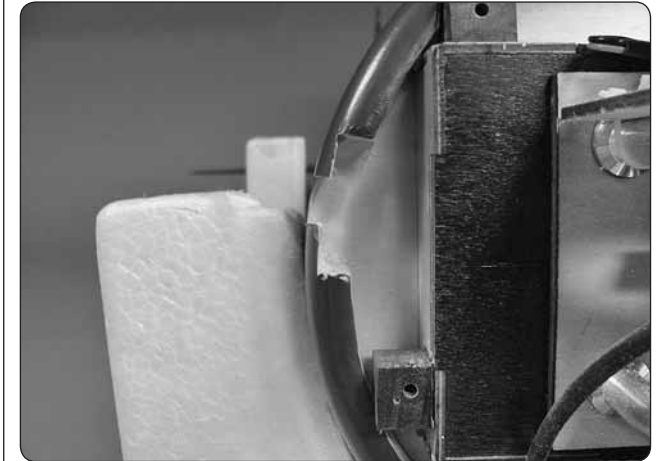

❑ 10. Using your choice of switch harness as a guide, cut an opening in the front of the fuselage as shown. This is best accomplished with a sharp hobby knife and a flat grinding bit in a high speed motor tool.



□ 11. Remove the required material to allow the switch to fit in the cavity with the side of the switch resting against the firewall.

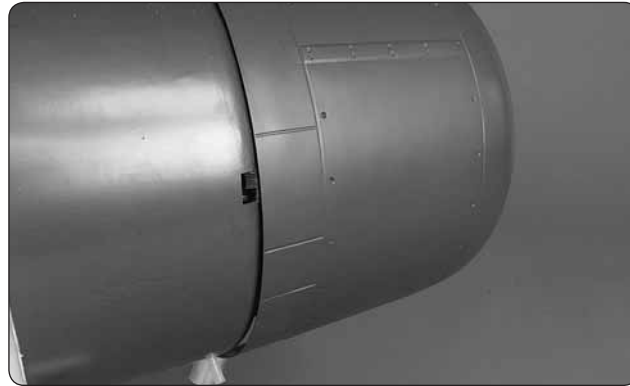
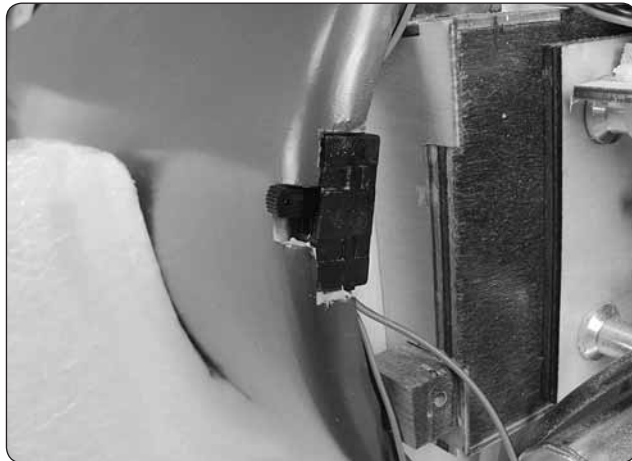

□ 12. Glue the switch in place. We used 5-minute epoxy for this. You might also consider the use of hot melt glue for this application. As the photo shows, if you have done a neat job of cutting the switch looks good when the cowl is installed.



□ 13. For our charge jack we used an Ernst charge receptacle. Like the switch, we glued it in place. Cut a hole to fit the charge receptacle.



□ 14. Glue the charge receptacle into the fuselage. We also used a couple of small wood screws. Because they are only screwed into balsa you will need to insert the screws and then remove them and apply a couple of drops of thin CA to harden the threads before re-inserting the screws. From the balsa that you cut away for the switch you might wish to glue balsa in place next to the switch to fill in the empty area. You can remove the covering from the scrap that you cut from the fuselage and reuse it to cover the scrap balsa you glued in place.



When the cowl is installed you can see that the switch and charge jack appear as a neat, clean installation.

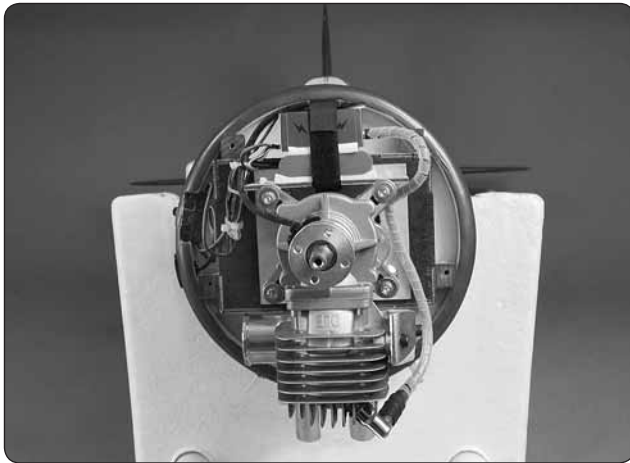

❑ 15. Following the instructions that came with the engine, finish the connections for the engine, ignition and the battery / switch harness. Be sure to secure the electrical connections with heat shrink tubing, tape or some other method. Use tie wraps to bundle the loose wires together for a clean installation.



One unusual store carried by the Corsair was an ice-cream factory. Late in the war one squadron in the Palaus found the action slow, and to stave off boredom the ground crews rigged 19-liter (5 US gallon) cans with a wind-driven spinner connected to a mixing rotor, and hooked up one under each wing of an F4U. A pilot would take the aircraft up to high altitude for a given period of time and then come back to base with the ice cream.

### INSTALL THE RECEIVER, BATTERY AND COMPLETE THE RADIO INSTALLATION

***Note:** Just a reminder, whenever a screw is threaded into wood sheeting or wood blocks we recommend that you install the screw and then remove it. Apply a drop of thin CA glue into the hole to harden the threads. After the glue has hardened, re-install the screw.*

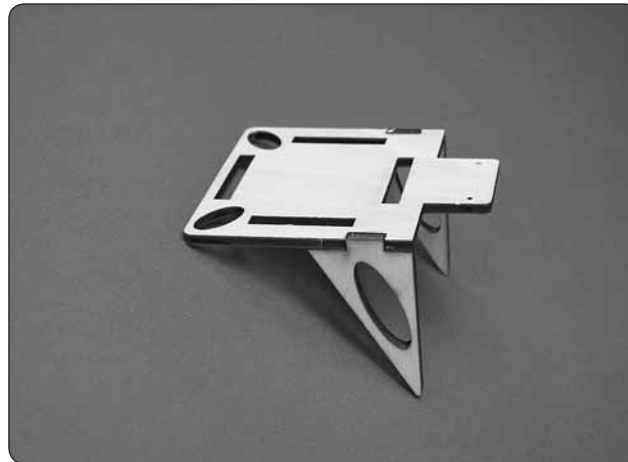
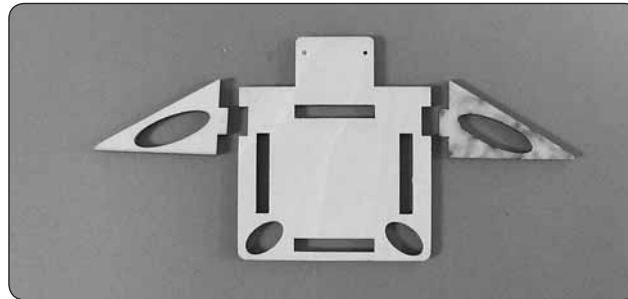

❑ 1. Locate the three components of the receiver tray. Glue them together as shown.

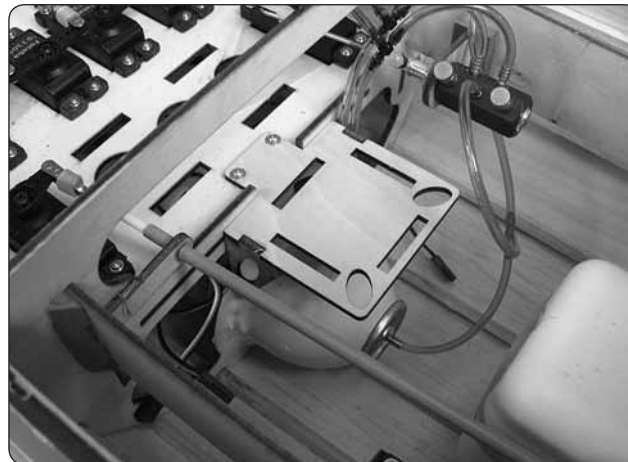

❑ 2. Drill a 1/16" [1.6mm] hole through the mounting tab and into the battery tray in the fuselage. Secure the tray with two #2 x 3/8" [9.6 mm] screws.



❑ 3. Install your radio switch and charge jack in the fuselage. Locate this switch as far away from the ignition switch and battery as is practical. It is generally recommended that you maintain 6"- 10" [254mm - 152mm]. Make all of the connections between the switch harness and the radio.



❑ 4. Insert a piece of R/C foam between the receiver tray and the battery. Secure the receiver and battery to the trays using the supplied Velcro.<sup>®</sup>

❑ 5. Connect all of the servos to the appropriate channels in your radio receiver.

## INSTALL THE COCKPIT, PILOT AND CANOPY

We have provided a cockpit interior that, on its own, gives a very realistic look to the interior of the aircraft. With a little time and creative use of additional materials you can make a very detailed interior. Look through the following instructions to gain a better understanding of how the cockpit goes together. The installation shown here is for the basic cockpit interior. If you are going to add additional detail you may wish to make those additions before you assemble the interior. Added details can be created more easily when the cockpit is not installed into the aircraft.

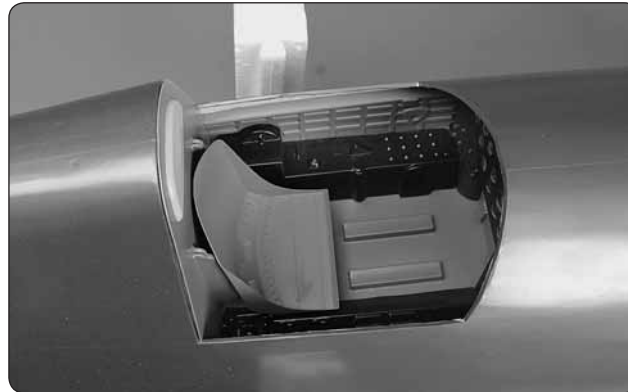
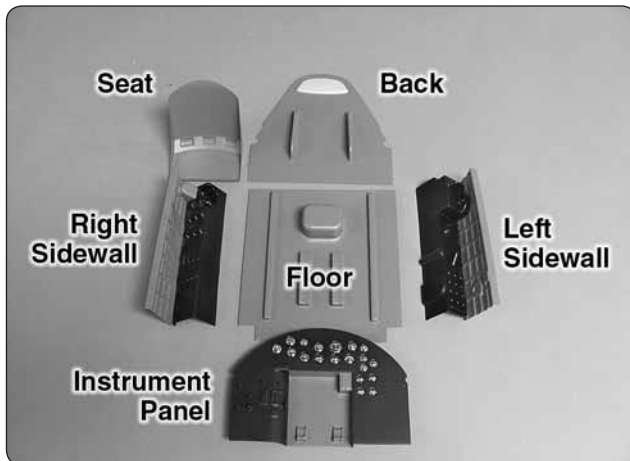

❑ 1. Install the components of the cockpit in the following order. Glue the cockpit floor into the fuselage followed by the rear wall, the instrument panel and then the two side walls. When the glue has dried, glue the seat to the pedestal molded into the cockpit floor.



❑ 2. You may wish to paint the exposed balsa wood above the side wall panel either a zinc chromate green or black.

❑ 3. A 1/5<sup>th</sup> scale pilot is correct for this model. We used a pilot from Vailly Aviation, [www.vaillyaviation.com](http://www.vaillyaviation.com). If you will be installing a pilot, glue it in place now.



❑ 4. We installed the canopy using R/C Z 56. This flexible glue adheres well to MonoKote® and dries completely clear. Glue the canopy to the fuselage. Tape it in place until the glue has completely dried.

## FINISHING TOUCHES

### FINISH THE COWL

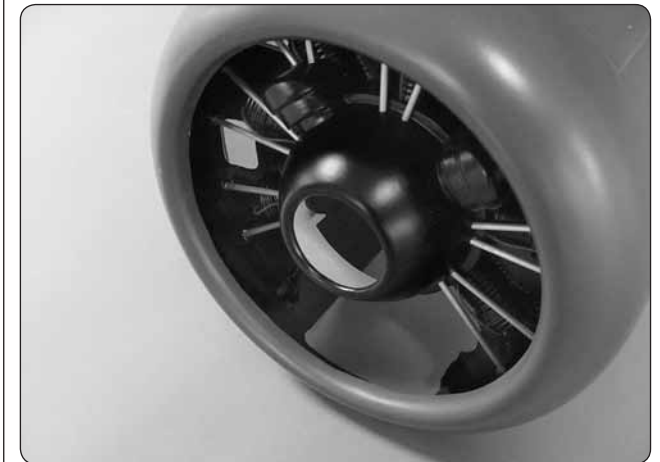

❑ 1. Though this is optional, you may wish to paint the inside of the cowl black in front of the dummy engine for a more scale appearance.

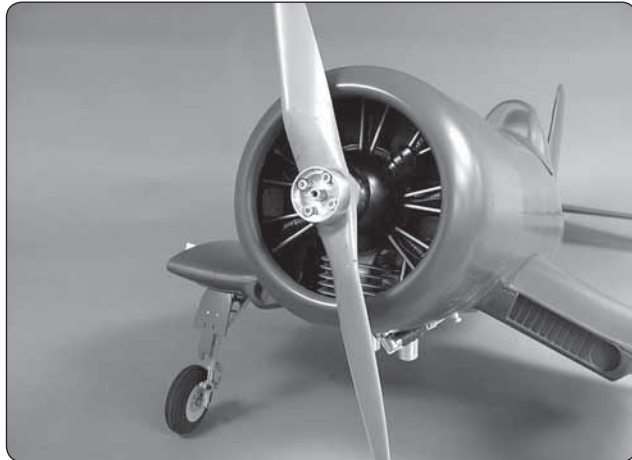
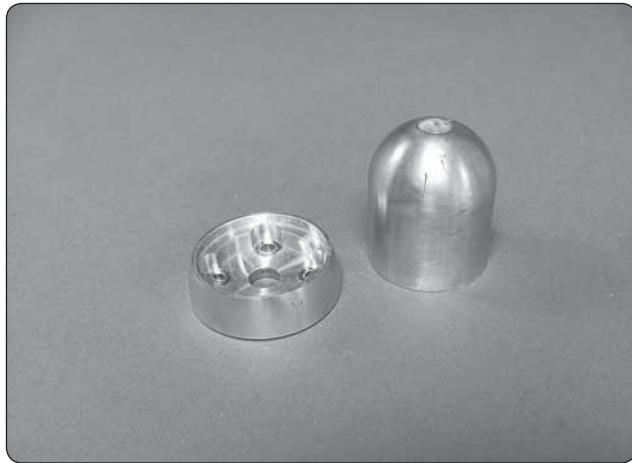

- ❑ 2. Locate the two piece aluminum spinner. Install the back plate onto the motor shaft using the mounting bolts that came with the engine. Secure the spinner with the 5 mm × 50mm socket head cap screw to the motor shaft. Be sure to apply a couple of drops of thread locker to the screw.

### APPLY THE DECALS

Refer to these pictures and the pictures on the box to determine the location for the decals. Use the following instructions to apply the decals.

- ❑ 1. Peel the decal from the decal sheet.
- ❑ 2. Be certain the model is clean and free from oily fingerprints and dust. Prepare a dishpan or small bucket with a mixture of liquid dish soap and warm water—about one teaspoon of soap per gallon of water. Submerge the decal in the soap and water and peel off the paper backing. **Note:** Even though the decals have a “sticky-back” and are not the water transfer type, submersing them in soap & water allows accurate positioning and reduces air bubbles underneath.
- ❑ 3. Position decal on the model where desired. Holding the decal down, use a paper towel to wipe most of the water away.
- ❑ 4. Use a piece of soft balsa or something similar to squeegee remaining water from under the decal. Apply the rest of the decals the same way.

## GET THE MODEL READY TO FLY

### CHECK THE CONTROL DIRECTIONS

- ❑ 1. Turn on the transmitter and receiver and center the trims. If necessary, remove the servo arms from the servos and reposition them so they are centered. Reinstall the screws that hold on the servo arms.
- ❑ 2. With the transmitter and receiver still on, check all the control surfaces to see if they are centered. If necessary, adjust the clevises on the pushrods to center the control surfaces.

### 4-CHANNEL RADIO SETUP (STANDARD MODE 2)

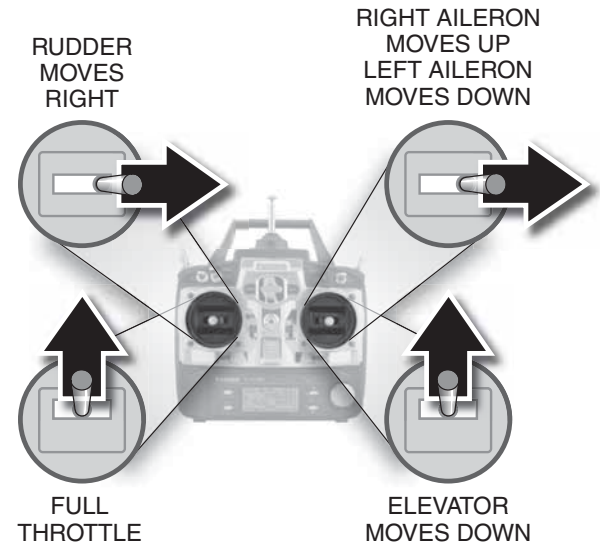

- ❑ 3. Make certain that the control surfaces and the carburetor respond in the correct direction as shown in the diagram. If any of the controls respond in the wrong direction, use the servo reversing in the transmitter to reverse the servos connected to those controls. Be certain the control surfaces have remained centered. Adjust if necessary.

### SET THE CONTROL THROWS

To ensure a successful first flight, set up your Corsair according to the control throws specified in this manual. The throws have been determined through actual flight testing and accurate record-keeping allowing the model to perform in the manner in which it was intended. If, after you have become accustomed to the way the Corsair flies, you would like to change the throws to suit your taste, that is fine. However, too much control throw could make the model too responsive and difficult to control, so remember, “more is not always better.”

- ❑ 1. Use a box or something similar to prop up the bottom of the fuselage so the horizontal stabilizer and wing will be level.

Measure the **high rate** elevator throw first...

- 2. Hold a ruler vertically on your workbench against the widest part (front to back) of the trailing edge of the elevator. Note the measurement on the ruler.



- 3. Move the elevator up with your transmitter and move the ruler forward so it will remain contacting the trailing edge. The distance the elevator moves up from center is the "up" elevator throw. Measure the down elevator throw the same way.

- 4. If necessary, adjust the location of the pushrod on the servo arm or on the elevator horn, or program the ATVs in your transmitter to increase or decrease the throw according to the measurements in the control throws chart.

- 5. Measure and set the **low rate** elevator throws and the high and low rate throws for the rest of the control surfaces the same way.

These are the recommended control surface throws:					
ELEVATOR	HIGH RATE		LOW RATE		
	Up	Down	Up	Down	
	3/4" [19mm]	3/4" [19mm]	1/2" [13mm]	1/2" [13mm]	
	11°	11°	7°	7°	
RUDDER	Right	Left	Right	Left	
	2-1/4" [57mm]	2-1/4" [57mm]	1-3/4" [44mm]	1-3/4" [44mm]	
	22°	22°	17°	17°	
AILERONS	Up	Down	Up	Down	
	1" [25mm]	1" [25mm]	3/4" [19mm]	3/4" [19mm]	
	21°	21°	16°	16°	
FLAPS		1-1/2" [38mm]			
		30°			

**NOTE:** The throws are measured at the **widest part** of the control surfaces.

**A note about flaps and mixing.** When you deploy the flaps expect it to balloon a bit. It is not severe but watch for it. We found that if you mix in 2 degrees of down elevator when the flaps are fully deployed that the ballooning was eliminated.

### BALANCE THE MODEL (C.G.)

More than any other factor, the C.G. (center of gravity/balance point) can have the greatest effect on how a model flies and could determine whether or not your first flight will be successful. If you value your model and wish to enjoy it for many flights, **DO NOT OVERLOOK THIS IMPORTANT PROCEDURE.** A model that is not properly balanced may be unstable and possibly unflyable.

At this stage the model should be in ready-to-fly condition with **all** of the components in place including

the complete radio system, engine, muffler, propeller, spinner and pilot.

- 1. Use a fine-point felt tip pen to mark lines on the top of wing on both sides of the fuselage 5-3/4" [146 mm] back from the leading edge. Apply narrow (1/16" [2mm]) strips of tape over the lines so you will be able to feel them when lifting the model with your fingers.

This is where your model should balance for the first flights. Later, you may experiment by shifting the C.G. 5/8" [16mm] forward or 3/8" [10mm] back to change the flying characteristics. Moving the C.G. forward will improve the smoothness and stability, but the model will then be less aerobatic (which may be fine for less-experienced pilots). Moving the C.G. aft makes the model more maneuverable and aerobatic for experienced pilots. In any case, **start at the recommended balance point** and do not at any time balance the model outside the specified range.

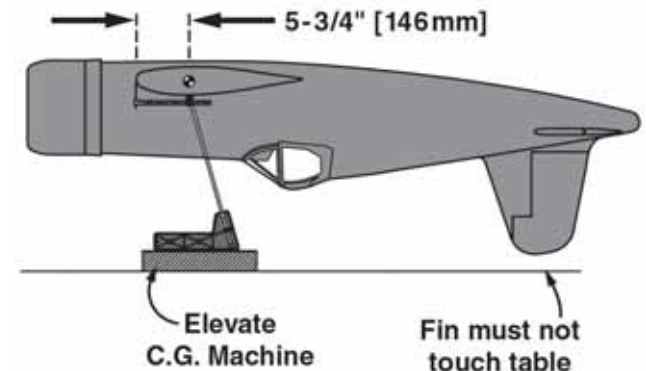

- 2. With the wing attached to the fuselage, all parts of the model installed (ready to fly) and an empty fuel tank, place the model upside-down on a Top Flite CG Machine,™ or lift it upside-down at the balance point you marked.

- 3. If the tail drops, the model is "tail heavy." If the nose drops, the model is "nose heavy." To find out how much weight is required to balance the model, place incrementally increasing amounts of weight on the

bottom of the fuselage over the location where it would be mounted inside until the model balances. Our model required nearly a pound of weight on the nose which we mounted to the firewall box. Do not attach weight to the cowl—this will cause the mounting screws to open up the holes in the cowl. Once you have determined the amount of weight required, it can be permanently attached. If required, tail weight may be added by cutting open the bottom of the fuse and gluing it permanently inside.

**Note:** If mounting weight where it may be exposed to fuel or exhaust, do not rely upon the adhesive on the back to permanently hold it in place. Over time, fuel and exhaust residue may soften the adhesive and cause the weight to fall off. Instead, permanently attach the weight with glue or screws.

❑ **4. IMPORTANT:** If you found it necessary to add any weight, recheck the C.G. after the weight has been installed.

## BALANCE THE MODEL Laterally

❑ 1. With the wing level, have an assistant help you lift the model by the engine propeller shaft and the bottom of the fuse under the TE of the fin. Do this several times.

❑ 2. If one wing always drops when you lift the model, it means that side is heavy. Balance the airplane by adding weight to the other wing tip. **An airplane that has been laterally balanced will track better in loops and other maneuvers.**

## PREFLIGHT

### IDENTIFY YOUR MODEL

No matter if you fly at an AMA sanctioned R/C club site or if you fly somewhere on your own, you should always have your name, address, telephone number and AMA number on or inside your model. It is **required** at all AMA R/C club flying sites and AMA sanctioned flying events. Fill out the identification tag on page 47 and place it on or inside your model.

## CHARGE THE BATTERIES

Follow the battery charging instructions that came with your radio control system to charge the batteries. You should always charge your transmitter and receiver batteries the night before you go flying, and at other times as recommended by the radio manufacturer.

**CAUTION:** Unless the instructions that came with your radio system state differently, the **initial** charge on **new** transmitter and receiver batteries should be done for 15 hours **using the slow-charger that came with the radio system.** This will “condition” the batteries so that the next charge may be done using the fast-charger of your choice. If the initial charge is done with a fast-charger the batteries may not reach their full capacity and you may be flying with batteries that are only partially charged.

## BALANCE PROPELLERS

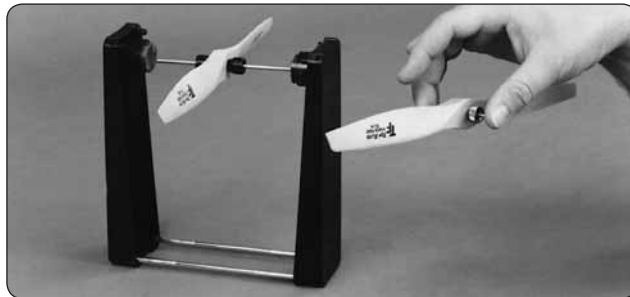

Carefully balance your propeller and spare propellers before you fly. An unbalanced prop can be the single most significant cause of vibration that can damage your model. Not only will engine mounting screws and bolts loosen, possibly with disastrous effect, but vibration may also damage your radio receiver and battery. Vibration can also cause your fuel to foam, which will, in turn, cause your engine to run hot or quit.

We use a Top Flite Precision Magnetic Prop Balancer (TOPQ5700) in the workshop and keep a Great Planes Fingertip Prop Balancer (GPMQ5000) in our flight box.

## GROUND CHECK AND RANGE CHECK

Run the engine for a few minutes to make sure it idles reliably, transitions smoothly and maintains full power indefinitely. Afterward, shut the engine off and inspect the model closely, making sure all fasteners, pushrods and connections have remained tight and the hinges are secure. Always ground check the operational range of your radio before the first flight of the day following the manufacturer’s instructions that came with your radio. This should be done once with the engine off and once with the engine running at various speeds. If the control surfaces do not respond correctly, **do not fly!** Find and correct the problem first. Look for loose servo connections or broken wires, corroded wires on old servo connectors, poor solder joints in your battery pack or a defective cell, or a damaged receiver crystal from a previous crash.

## ENGINE SAFETY PRECAUTIONS

**Failure to follow these safety precautions may result in severe injury to yourself and others.**

- Keep all engine fuel in a safe place, away from high heat, sparks or flames, as fuel is very flammable. Do not smoke near the engine or fuel; and remember that engine exhaust gives off a great deal of deadly carbon monoxide. Therefore **do not run the engine in a closed room or garage.**
- Get help from an experienced pilot when learning to operate engines.
- Use safety glasses when starting or running engines.
- Do not run the engine in an area of loose gravel or sand; the propeller may throw such material in your face or eyes.
- Keep your face and body as well as all spectators away from the plane of rotation of the propeller as you start and run the engine.
- Keep these items away from the prop: loose clothing, shirt sleeves, ties, scarfs, long hair or loose objects such as pencils or screwdrivers that may fall out of shirt or jacket pockets into the prop.

- Use a “chicken stick” or electric starter to start the engine. Do not use your fingers to flip the propeller.
- Make all engine adjustments from behind the rotating propeller.
- The engine gets hot! Do not touch it during or right after operation. Make sure fuel lines are in good condition so fuel will not leak onto a hot engine, causing a fire.

## AMA SAFETY CODE (excerpts)

Read and abide by the following excerpts from the Academy of Model Aeronautics Safety Code. For the complete Safety Code refer to *Model Aviation* magazine, the AMA web site or the Code that came with your AMA license.

### GENERAL

- 1) I will not fly my model aircraft in sanctioned events, air shows, or model flying demonstrations until it has been proven to be airworthy by having been previously, successfully flight tested.
- 2) I will not fly my model aircraft higher than approximately 400 feet within 3 miles of an airport without notifying the airport operator. I will give right-of-way and avoid flying in the proximity of full-scale aircraft. Where necessary, an observer shall be utilized to supervise flying to avoid having models fly in the proximity of full-scale aircraft.
- 3) Where established, I will abide by the safety rules for the flying site I use, and I will not willfully and deliberately fly my models in a careless, reckless and/or dangerous manner.
- 5) I will not fly my model unless it is identified with my name and address or AMA number, on or in the model. Note: This does not apply to models while being flown indoors.
- 7) I will not operate models with pyrotechnics (any device that explodes, burns, or propels a projectile of any kind).

### RADIO CONTROL

- 1) I will have completed a successful radio equipment ground check before the first flight of a new or repaired model.
- 2) I will not fly my model aircraft in the presence of spectators until I become a qualified flier, unless assisted by an experienced helper.
- 3) At all flying sites a straight or curved line(s) must be established in front of which all flying takes place with the other side for spectators. Only personnel involved with flying the aircraft are allowed at or in the front of the flight line. Intentional flying behind the flight line is prohibited.
- 4) I will operate my model using only radio control frequencies currently allowed by the Federal Communications Commission.
- 5) **I will not knowingly operate my model within three miles of any pre-existing flying site except in accordance with the frequency sharing agreement listed [in the complete AMA Safety Code].**
- 9) Under no circumstances may a pilot or other person touch a powered model in flight; **nor should any part of the model other than the landing gear, intentionally touch the ground, except while landing.**

### CHECK LIST

During the last few moments of preparation your mind may be elsewhere anticipating the excitement of the first flight. Because of this, you may be more likely to overlook certain checks and procedures that should be performed before the model is flown. To help avoid this, a check list is provided to make sure these important areas are not overlooked. Many are covered in the instruction manual, so where appropriate, refer to the manual for complete instructions. Be sure to check the items off as they are completed (that's why it's called a *check list!*).

1. Fuelproof all areas exposed to fuel or exhaust residue such as the cowl ring, cowl mounting blocks, wing saddle area, etc.

2. Check the C.G. according to the measurements provided in the manual.
3. Be certain the battery and receiver are securely mounted in the fuse. Simply stuffing them into place with foam rubber is not sufficient.
4. Extend your receiver antenna.
5. Balance your model *laterally* as explained in the instructions.
6. Use threadlocking compound to secure critical fasteners such as the set screws that hold the wheel axles to the struts, screws that hold the carburetor arm (if applicable), screw-lock pushrod connectors, etc.
7. Add a drop of oil to the axles so the wheels will turn freely.
8. Make sure all hinges are **securely** glued in place.
9. Reinforce holes for wood screws with thin CA where appropriate (servo mounting screws, cowl mounting screws, etc.).
10. Confirm that all controls operate in the correct direction and the throws are set up according to the manual.
11. Make sure there are silicone retainers on all the clevises and that all servo arms are secured to the servos with the screws included with your radio.
12. Secure connections between servo wires and Y-connectors or servo extensions, and the connection between your battery pack and the on/off switch with vinyl tape, heat shrink tubing or special clips suitable for that purpose.
13. Make sure any servo extension cords you may have used do not interfere with other systems (servo arms, pushrods, etc.).
14. Make sure the fuel lines are connected and are not kinked.
15. Balance your propeller (and spare propellers).
16. Tighten the propeller nut and spinner.
17. Place your name, address, AMA number and telephone number on or inside your model.

- 18. Cycle your receiver battery pack (if necessary) and make sure it is fully charged.
- 19. If you wish to photograph your model, do so before your first flight.
- 20. Range check your radio when you get to the flying field.

## FLYING

**IMPORTANT!!!** The Corsair is a great-flying model that flies smoothly and predictably. The Corsair does not, however, possess the self-recovery characteristics of a primary R/C trainer and should be flown only by experienced R/C pilots.

### FUEL MIXTURE ADJUSTMENTS

A fully cowled engine may run at a higher temperature than an un-cowled engine. For this reason, the fuel mixture should be richened so the engine runs at about 200 rpm below peak speed. By running the engine slightly rich, you will help prevent dead-stick landings caused by overheating.

### CAUTION (THIS APPLIES TO ALL R/C AIRPLANES):

If, while flying, you notice an alarming or unusual sound such as a low-pitched “buzz,” this may indicate control surface *flutter*. Flutter occurs when a control surface (such as an aileron or elevator) or a flying surface (such as a wing or stab) rapidly vibrates up and down (thus causing the noise). In extreme cases, if not detected immediately, flutter can actually cause the control surface to detach or the flying surface to fail, thus causing loss of control followed by an impending crash. The best thing to do when flutter is detected is to slow the model **immediately** by reducing power, then land as soon as safely possible. Identify which surface fluttered (so the problem may be resolved) by checking all the servo grommets for deterioration or signs of vibration. Make certain all pushrod linkages are secure and free of play. If it fluttered once, under similar circumstances it will probably flutter again unless the problem is fixed. Some things which can cause flutter are; Excessive hinge gap; Not mounting control horns solidly; Poor fit of clevis pin in horn; Side-play of wire pushrods caused by large bends; Excessive free play in servo gears; Insecure servo mounting; and one of the most prevalent causes of flutter; Flying an over-powered model at excessive speeds.

### TAKEOFF

Before you get ready to takeoff, see how the model handles on the ground by doing a few practice runs at **low speeds** on the runway. Hold “up” elevator to keep the tail wheel on the ground. If necessary, adjust the tail wheel so the model will roll straight down the runway. If you need to calm your nerves before the maiden flight, shut the engine down and bring the model back into the pits. Top off the fuel, then check all fasteners and control linkages for peace of mind.

Remember to takeoff into the wind. When you’re ready, point the model straight down the runway, hold a bit of up elevator to keep the tail on the ground to maintain tail wheel steering, then gradually advance the throttle. As the model gains speed decrease up elevator allowing the tail to come off the ground. One of the most important

things to remember with a tail dragger is to always be ready to apply **right** rudder to counteract engine torque. Gain as much speed as your runway and flying site will practically allow before gently applying up elevator, lifting the model into the air. At this moment it is likely that you will need to apply more right rudder to counteract engine torque. Be smooth on the elevator stick, allowing the model to establish a **gentle** climb to a safe altitude before turning into the traffic pattern.

### FLIGHT

For reassurance and to keep an eye on other traffic, it is a good idea to have an assistant on the flight line with you. Tell him to remind you to throttle back once the plane gets to a comfortable altitude. While full throttle is usually desirable for takeoff, most models fly more smoothly at reduced speeds.

The Corsair has a great presence in the air and is fully capable of all prototypical maneuvers that the full size Corsair could do. Rolls, point rolls, wingovers and large loops all look great and of course a low fly by always grabs the attention of those watching.

Take it easy with the Corsair for the first few flights, gradually getting acquainted with it as you gain confidence. Adjust the trims to maintain straight and level flight. After flying around for a while, and while still at a safe altitude with plenty of fuel, practice slow flight and execute practice landing approaches by reducing the throttle to see how the model handles at slower speeds. Deploy the flaps to see how they affect the plane, following the comments in the **LANDING** section. Add power to see how she climbs as well. Continue to fly around, executing various maneuvers and making mental notes (or having your assistant write them down) of what trim or C.G. changes may be required to fine tune the model so it flies the way you like. Mind your fuel level, but use this first flight to become familiar with your model before landing.

### LANDING

To initiate a landing approach, lower the throttle while on the downwind leg. Allow the nose of the model to pitch downward to gradually bleed off altitude. Continue to lose altitude, but maintain airspeed by keeping the nose

down as you turn onto the crosswind leg and deploy the flaps. When you deploy the flaps expect it to balloon a bit. It is not severe but watch for it. *(We found that if you mix in 2 degrees of down elevator when the flaps are fully deployed that the ballooning was eliminated).* We recommend you spend some time flying at altitude with the flaps deployed, flying at slower speeds. Make your final turn toward the runway (into the wind) keeping the nose down to maintain airspeed and control. Level the attitude when the model reaches the runway threshold, modulating the throttle as necessary to maintain your glide path and airspeed. If you are going to overshoot, smoothly advance the throttle (always ready on the right rudder to counteract torque) and climb out to make another attempt. When you're ready to make your landing flare and the model is a foot or so off the deck, smoothly increase up elevator until it gently touches down. Once the model is on the runway and has lost flying speed, hold up elevator to place the tail on the ground, regaining tail wheel control.

If you are not accustomed to an airplane with flaps you will discover that landings are slightly different. A typical model without flaps will generally initiate a landing approach with a gradual reduction in altitude so that on the final approach you will be at a fairly low altitude and will drive the airplane to the runway. The Corsair lands best if you make your final approach at about 100 feet (30 meters) as you approach the end of the runway. Gradually reduce your speed, and point the nose towards the end of the runway, maintaining a steady descent. Level the airplane about three feet (1 meter) above the runway and allow the plane to touch down on the main gear and roll out until the tail naturally settles onto the runway.

One final note about flying your model. Have a goal or flight plan in mind for **every** flight. This can be learning a new maneuver(s), improving a maneuver(s) you already know, or learning how the model behaves in certain conditions (such as on high or low rates).

This is not necessarily to improve your skills (*though it is never a bad idea!*), but more importantly so you do not surprise yourself by impulsively attempting a maneuver and suddenly finding that you've run out of time, altitude or airspeed. Every maneuver should be deliberate, not impulsive. For example, if you're going to do a loop, check your altitude, mind the wind direction (anticipating rudder corrections that will be required to maintain heading), remember to throttle back at the top, and make certain you are on the desired rates (high/low rates). A flight plan greatly reduces the chances of crashing your model just because of poor planning and impulsive moves. **Remember to think.**

**Have a ball! But always stay in control and fly in a safe manner.**

***GOOD LUCK AND GREAT FLYING!***



## ROBERT ELECTRIC RETRACT SYSTEM

Robert has a new Electric Retract System that scale enthusiasts will love. The electric system allows for full control of the speed of the landing gear movement and allows the gear to go up and down at the same speed as well as staggering the deployment of the landing gear. This system has the identical footprint to the pneumatic gear so they are interchangeable with the pneumatic system. If you choose to use these in your Top Flite Giant Corsair simply install them using the procedure outlined in this manual, ignoring the instructions about the air lines, control valve, etc and use the instructions with the landing gear.

148-E Electric Mains TF Giant F4U Corsair (ROBQ1656)  
160WC-E Fork Electric Retract Tail Wheel (ROBQ2231)  
Retract Controller (ROBQ2178)  
Life Battery

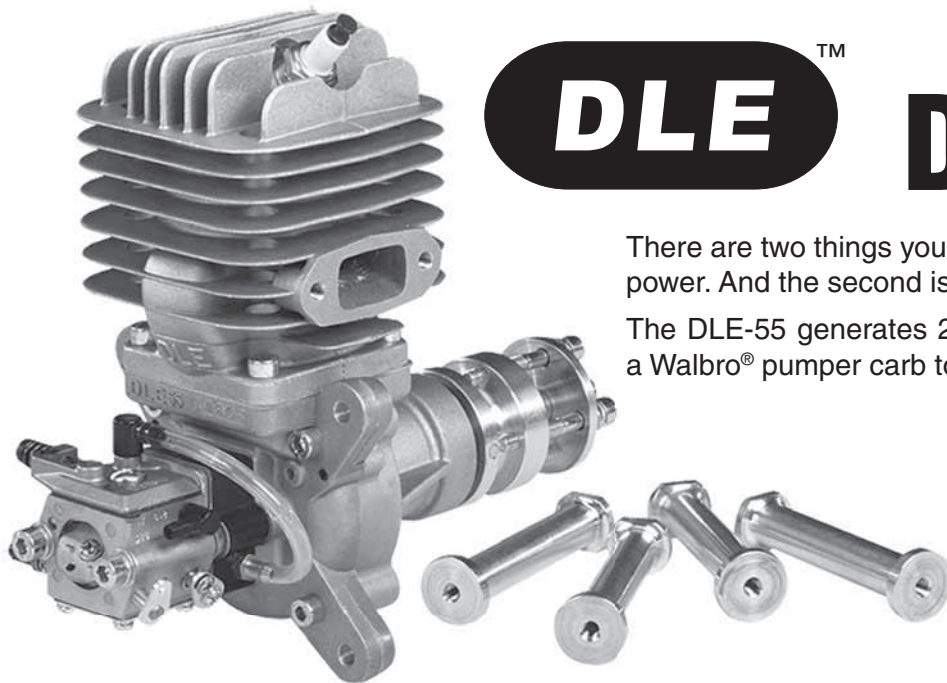
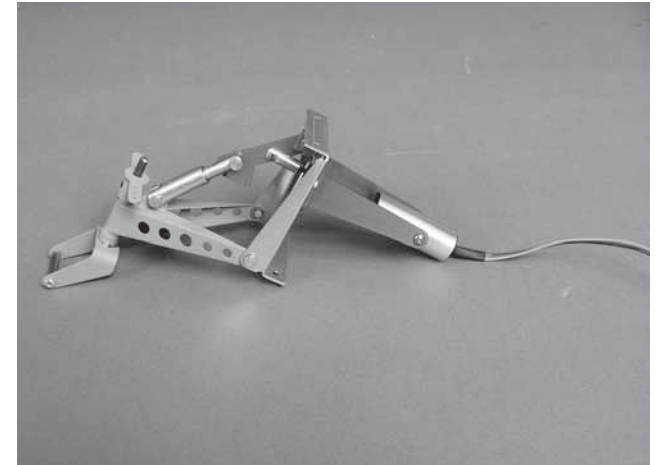
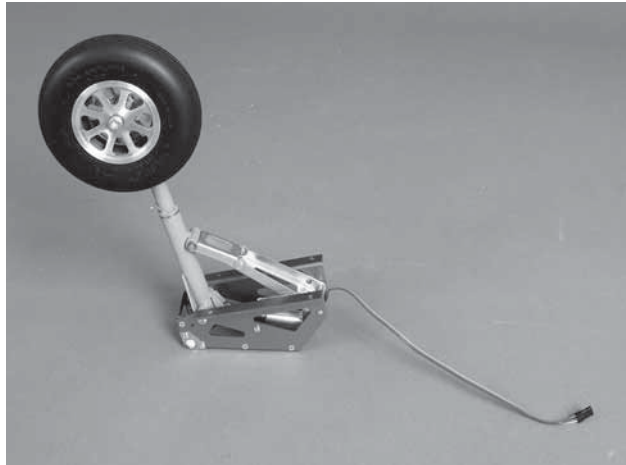

# **DLE**<sup>TM</sup> **DLE-55 Gas Engine**

There are two things you can count on in giant scale. The first is that you can always use a little more power. And the second is that there's a DLE engine to deliver it.

The DLE-55 generates 2.2-4.4 more pounds of static thrust than the original DLE-50 and includes a Walbro® pumper carb to make the most of it. It makes dependability, control and power affordable.

**Displacement:** 55.6 cc (3.392 cu in)  
**Bore:** 1.77 in (45 mm)  
**Stroke:** 1.38 X in (35 mm)

**Weight:** 3.6 lb (1.65 g)  
**RPM Range:** 1,350-8,500  
**Output:** 5.5 hp @ 7,500 rpm

**Requires:** unleaded gasoline, oil, ignition battery & propeller  
**Includes:** electronic ignition, muffler, spark plug, gasket, bolts, machined aluminum standoffs, throttle arm extension & manual

## DLE 55 Mounting Pattern

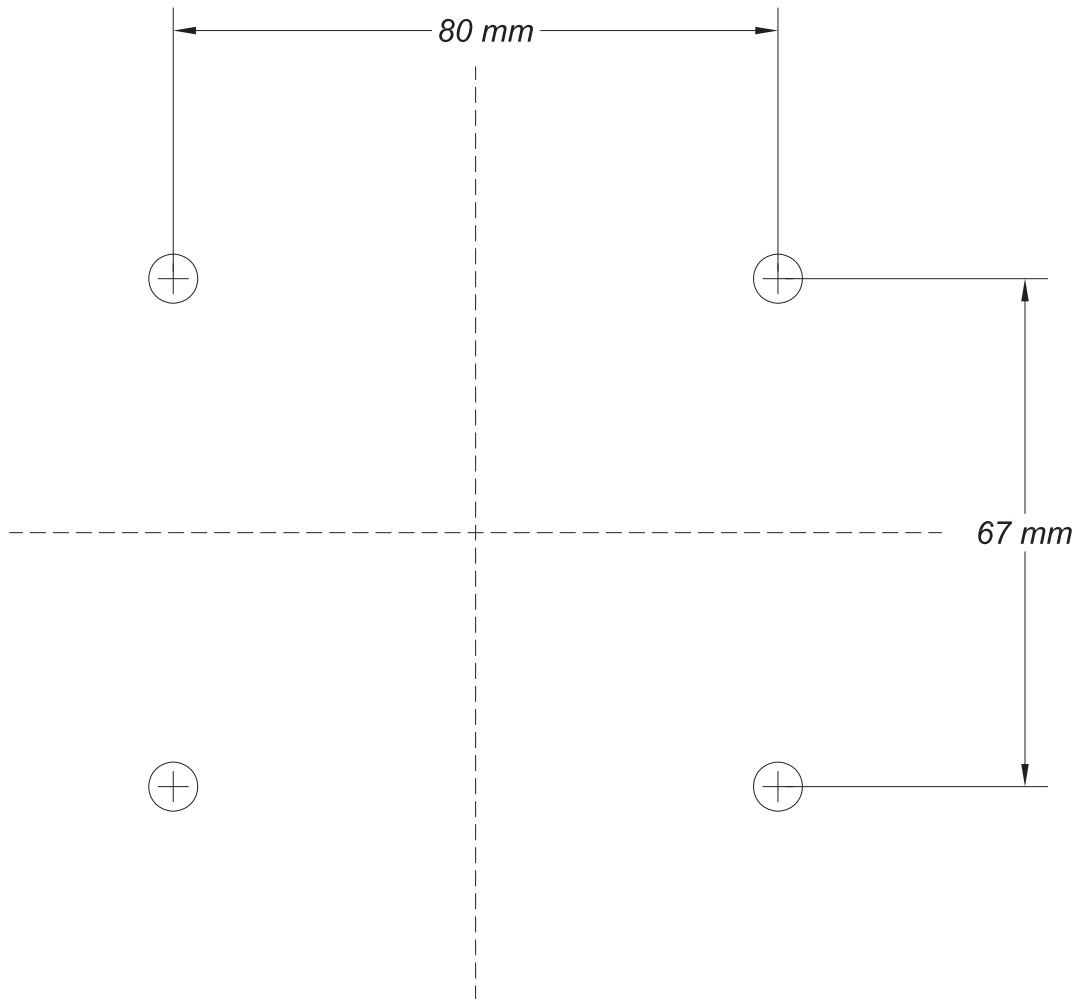

## Identification Tag

This model belongs to:

---

Name

---

Address

---

City, State, Zip

---

Phone Number

---

AMA Number

