

ULTIMETER® 800 OWNER'S MANUAL

TABLE OF CONTENTS

	<u>Page No.</u>
QUICK START	3
I. INTRODUCTION.....	9
II. PRE-INSTALLATION TESTING.....	10
III. PLANNING YOUR INSTALLATION.....	16
IV. INSTALLING ULTIMETER 800 COMPONENTS.....	20
V. CONNECTING YOUR ULTIMETER 800 SYSTEM.....	23
VI. INITIAL SETTINGS.....	25
SET YEAR.....	25
SET DATE AND DATE FORMAT.....	25
RESET LONG-TERM MEMORIES.....	25
SET TIME AND TIME FORMAT.....	26
SELECT TEMPERATURE UNITS.....	26
SELECT WIND SPEED UNITS.....	26
SELECT RAIN GAUGE INCREMENTS & UNITS.....	27
TO ADJUST THE LONG-TERM RAIN TOTAL.....	29
VII. DISPLAYING CURRENT DATA.....	30
VIII. THE ULTIMETER 800 HI/LO MEMORY SYSTEM.....	32
IX. DISPLAYING STORED DATA.....	33
TO DISPLAY HIGHEST VALUES.....	33
TO DISPLAY LOWEST VALUES.....	33
TO DISPLAY RAINFALL.....	34
X. RESETTING LONG-TERM MEMORY VALUES.....	35
TO RESET A SINGLE LONG-TERM HI OR LO.....	35
TO RESET ALL LONG-TERM HI & LO MEMORIES.....	35
XI. ALARMS.....	36
TO SET AN ALARM.....	36
THE RAIN RATE ALARM.....	37
TO MOMENTARILY STOP AN ALARM.....	38
TO DISABLE AN ALARM.....	38
XII. THE ULTIMETER 800 SERIAL PORT.....	39
WEATHERTEXT OUTPUT MODE.....	39
COMPLETE RECORD MODE.....	39
DATA LOGGER MODE.....	40
PACKET MODE.....	40
COMPLETE HISTORY MODE.....	40
MULTIPLE OUTPUT MODE.....	40
MODEM MODE.....	40
XIII. SUPPLEMENTAL WIND VANE CALIBRATION.....	41
XIV. TEMPERATURE OFFSET ADJUSTMENT.....	42
XV. HUMIDITY OFFSET ADJUSTMENT.....	43
XVI. ROUTINE MAINTENANCE.....	44
XVII. REPAIR & EXCHANGE SERVICE.....	45
XVIII. SPECIFICATIONS.....	46
IX. AVAILABLE ACCESSORIES.....	50

Continued On Next Page

QUICK START GUIDE

FOR THOSE WHO DON'T HAVE TIME TO READ INSTRUCTIONS

(AND THOSE WHO DO)

In addition to these few "Quick Start" paragraphs, please be sure to read the section on installation very carefully. It includes important safety information as well as time saving installation tips.

SUGGESTION: DO NOT UNCOIL CABLES UNTIL YOU HAVE TESTED AND BECOME FAMILIAR WITH ALL COMPONENTS AND ARE READY TO INSTALL THE SYSTEM.

ABOUT THE KEYBOARD

There are ten "data keys," each identified by a symbol as shown below:

WIND SPEED	WIND CHILL	TEMP	RAIN	BAROMETER*
		d.p.		
INDOOR	HUMIDITY	DEW POINT	TIME	DATE

*optional sensor

In addition, there are six "utility keys," each identified by a symbol as shown below:

SCAN	LAMP	CLEAR	ALARM	DOWN	UP





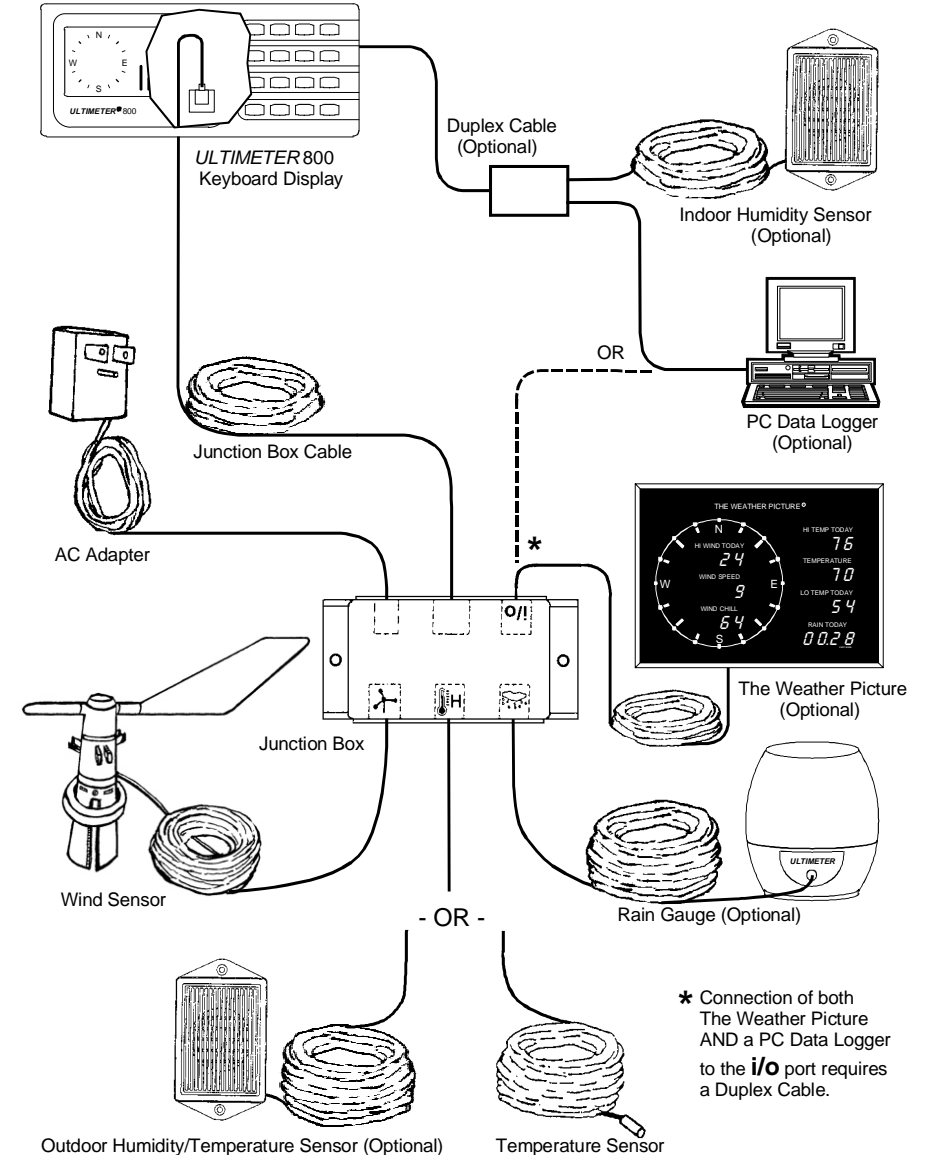

CONNECT SYSTEM COMPONENTS

Connect components to Junction Box as shown in diagram below. Refer to the section "Installing Your *ULTIMETER* 800 Components".



NOTE: The Weather Picture requires a 12v/1000mA AC Adapter be used in place of the 12v/400mA AC Adapter supplied with the *ULTIMETER* 800. Also, BEFORE YOU INSTALL PLUGS IN RECEPTACLES, be sure to check connectors as shown on p. 13.



TO DISPLAY WIND SPEED, WIND CHILL, TEMPERATURE, HUMIDITY, DEW POINT, TIME, OR DATE

Press and release the desired data key: , , , , , , or . The corresponding symbol will appear on the screen and the current data value will be displayed.



NOTE: When you press  or , the instrument will display the outdoor temperature or outdoor humidity.

TO DISPLAY WIND DIRECTION



After installation, the *ULTIMETER* 800 will constantly indicate the prevailing wind direction on its 16 point compass rose. The system minimizes confusing "jitters" by ignoring momentary direction changes that occur during transient wind gusts. It also avoids erroneous readings, by "locking" the wind direction display when there is no wind, i.e. when the cups are not spinning. Therefore, in order to test or demonstrate the wind direction function, you must spin the cups. You'll find it is best to blow somewhat steadily on the cups, rather than abruptly spinning the anemometer rotor with your fingers.

The current wind direction in degrees ($^{\circ}$) is displayed by pressing the  key twice (the first press displays the current wind speed): N=0 $^{\circ}$, E=90 $^{\circ}$, S=180 $^{\circ}$, W=270 $^{\circ}$, etc. Pressing the  key again returns the display to the current wind speed.

TO DISPLAY INDOOR TEMPERATURE OR INDOOR HUMIDITY









- Press and release  to display outdoor temperature or  to display outdoor humidity.
- Next, press and release  to change display from outdoor reading to indoor reading.

TO DISPLAY HEAT INDEX TEMPERATURE





Press and release  twice to display heat index (the first press displays the dew point). The  and  symbols will alternately flash in the display to indicate heat index.

Pressing  again returns the display to the dew point temperature.

TO DISPLAY HIGHEST AND LOWEST READINGS

- Press the desired data key to display the current value.
- To display TODAY'S highest or lowest values (since midnight), press  or  once. The display will repeatedly cycle through today's date, today's high or low value, and the time at which it occurred.
- To display PREVIOUS DAY'S highest or lowest values (from midnight to midnight), press  or  again, repeatedly, to display the values for each of the LAST SEVEN DAYS. After each press, the display will repeatedly cycle through: the selected date, that day's high or low value, and the time at which it occurred.
- To display the LONG TERM High or Low values (since last RESET), press  or  a ninth time. The display will repeatedly cycle through: the date on which the high or low occurred, the highest or lowest value since last reset, and the time at which it occurred. This display mode is easily recognized by the flashing  when the date is displayed.
- Pressing  or  a tenth time returns the display to TODAY'S high or low value.





TO DISPLAY RAINFALL

- To display TODAY'S rainfall (since midnight), press .
- To display PREVIOUS DAY'S rainfall (from midnight to midnight) press , repeatedly, to display daily rainfall for each of the LAST SEVEN DAYS. The display will alternate between the selected date and that day's total rainfall.
- To display the LONG-TERM ACCUMULATED rainfall (since you last reset this value to zero), press  an eighth time. The display will alternate between the date you last reset this total and the rainfall accumulation since that date.
- Pressing  a ninth time returns the display to TODAY'S rainfall.

TO CHANGE MEASUREMENT UNITS OR FORMAT

NOTE: The *ULTIMETER* 800 is designed to minimize the chance of someone else accidentally clearing your data or changing your settings. That is why, in many of the procedures below, you must first display the value you wish to change, then press and hold a key for 3-4 seconds before settings are cleared or changed.

Use the procedure below to select: Wind Speed in mph, m/s, knots, or km/h; Temperatures in Fahrenheit or Celsius; Time in 12- or 24-hr format; Date in day/month or month/day format; Rainfall increments of 0.01 in, 0.25 mm, 0.1 in, 0.1 mm, or 2.5 mm according to your preference and the type of rain gauge you are using.



a) Press and hold the desired data key: , , , , or . KEEP IT PRESSED UNTIL THE DISPLAY CHANGES (after flashing three times).



NOTE: Units for wind chill , dew point  (d.p.), and heat index will be the same as for temperature.



b) Repeat this step until data is displayed in the desired units or format.



TO ADJUST TIME, DATE, AND YEAR SETTING

This instrument features a perpetual calendar. For it to operate correctly, you must set the current year before you set the day and month.

a) Press and release  and  simultaneously. The clock and calendar symbols will appear on the screen and the instrument will display the year setting (default is 2009).

b) Press  and KEEP IT PRESSED until the year begins to change. Then press  or  as required until the display shows the current year.

c) Press and release  to set time or  to set date.

d) Press and hold  or  as required until the displayed value is close to correct, then press repeatedly until correct setting is displayed. Press any data key to return to normal operation.

ANSWERS TO A FEW MOST LIKELY QUESTIONS . . .

WHAT IS THE  BUTTON FOR?

This button activates display backlighting, for viewing in a dark room. Pressing the button once turns backlighting on, and pressing it again turns it off. Backlighting may be left on continuously if desired.

WHAT DOES THE BATTERY SYMBOL MEAN?

The battery symbol (not flashing) means the instrument is operating from battery power. Likely causes are a disconnected AC adapter, an AC power outage, or a faulty AC adapter.

WHAT DOES A FLASHING BATTERY SYMBOL MEAN?

The battery symbol will flash if the battery is weak, or if no battery has been installed.

WHAT IS THE MODULAR 6-CONDUCTOR JACK ON THE SIDE OF THE CONTROL UNIT?

This jack is an RS232-compatible Serial Data I/O jack. It is used for sending weather data to a personal computer or other external device, such as The Weather Picture, Weather Vox, or a radio transmitter. It is also used for connecting the optional Indoor Relative Humidity Sensor.

An additional Serial Data Output port is located in the junction box (labeled "i/o").



I. INTRODUCTION

Congratulations on selecting The *ULTIMETER* 800 Weather Station. To take full advantage of its advanced features, please take a few minutes to read through and follow this short booklet. Its simple step-by-step instructions will speed you through system installation and help assure you many years of complete satisfaction.

SUGGESTION: DO NOT UNCOIL CABLES UNTIL YOU HAVE TESTED AND BECOME FAMILIAR WITH ALL COMPONENTS AND ARE READY TO INSTALL THE SYSTEM.

IMPORTANT NOTE CONCERNING WIND DIRECTION:

The *ULTIMETER* 800 is designed to detect and display the prevailing wind direction on its 16 point compass rose. The system minimizes confusing "jitters" by ignoring momentary direction changes that occur during transient wind gusts. It also avoids erroneous readings, by "locking" the direction display when there is no wind, i.e. when the cups are not spinning. Therefore, in order to test or demonstrate the wind direction function, you must spin the cups. You'll find it is best to blow somewhat steadily on the cups, rather than abruptly spinning the anemometer housing with your fingers.

The current wind direction in degrees (°) is displayed by pressing the  key twice (the first press displays the current wind speed). Pressing the  key again returns the display to the current wind speed.

II. PRE-INSTALLATION TESTING

Before you uncoil any cables, you should interconnect and test the system components, as described below. This will allow you to become familiar with the system and assure that all components are functioning properly before you install them.

Setup

1. Carefully remove each component from its shipping container and place them all on a clear work area.
2. As shown below, identify the basic system components and any accessories you have ordered.

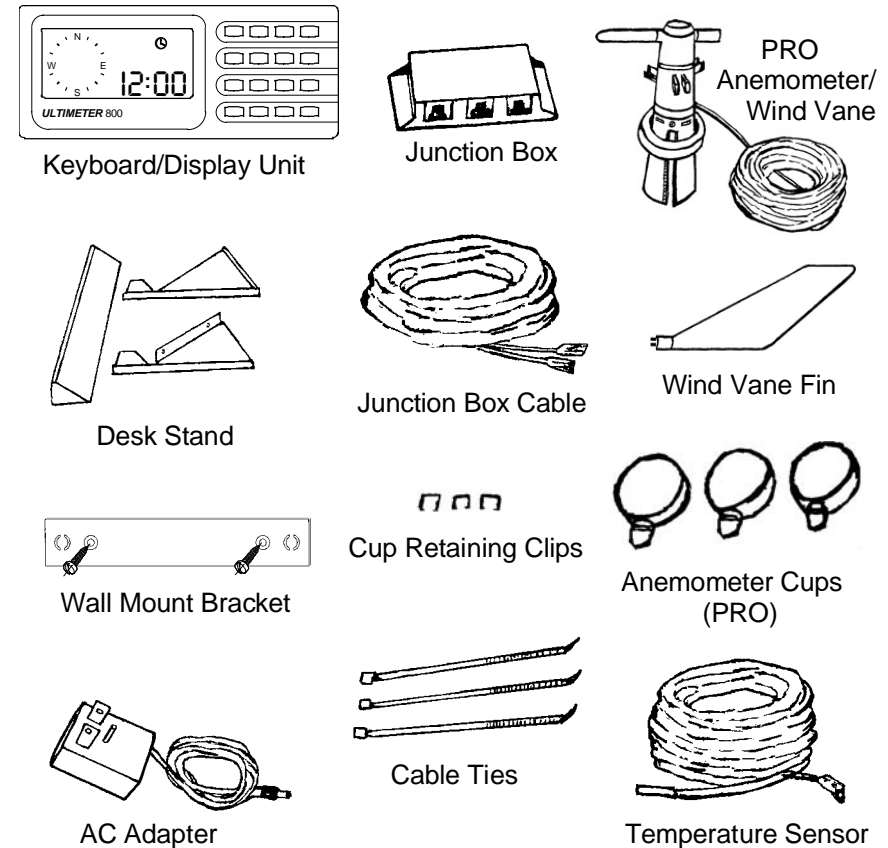

Not shown: 2 screws for desk stand; 2 screws for wall mounting keyboard/display unit; 2 drywall screws for wall mounting keyboard unit; mounting bracket and screw for temperature sensor.

3. Install Anemometer Cups

Plug each cup firmly into place on the anemometer rotor housing. Be sure that each cup arm snaps solidly.

NOTE: THE CUPS MUST BE ORIENTED AS SHOWN OR WIND DIRECTION WILL BE INCORRECTLY DISPLAYED, AND THE CUPS WILL NOT PROPERLY LOCK INTO PLACE.



CUP ORIENTATION

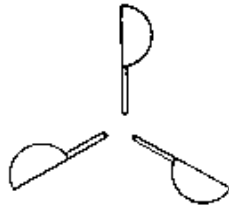

(viewed from above)

4. Install Cup Retaining Clips (PRO Anemometer Only)

Spread the metal retaining clip apart and over the top of each cup connection as shown.

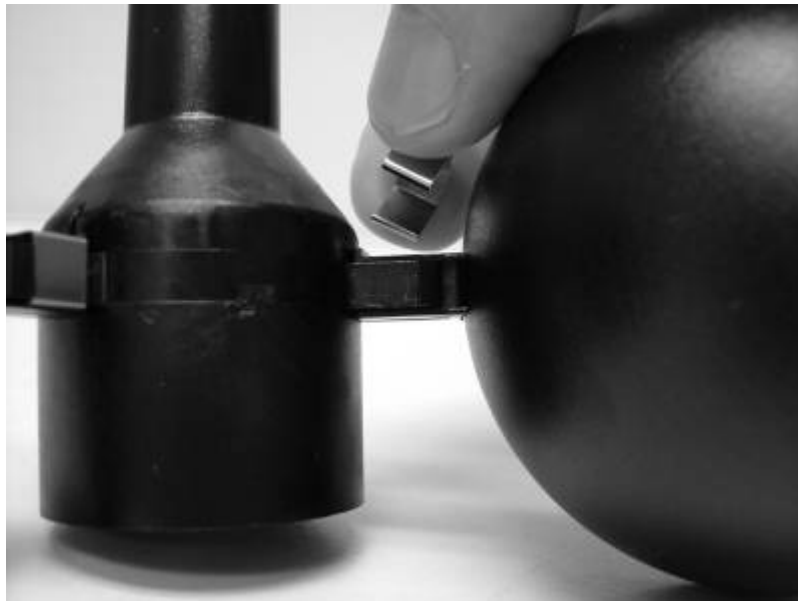

Press down until clip is FULLY seated. Press the sides of the clip to be sure the clip wraps around the bottom side of the cup connection.







5. Install the Wind Vane Fin

Insert the fin into the open end of the wind vane pointer as shown. Press in firmly until a “snap” is felt.



6. Select the correct Anemometer Calibration

The correct anemometer (PRO, w/2.6” cups, or Standard, w/1.2” cups) must be selected on the *ULTIMETER* keyboard/display for wind speed to be properly calculated and displayed.

- Press  and  buttons simultaneously to display the presently selected anemometer. The default setting is “PRO”.
- To change setting between “PRO” anemometer and “Std” anemometer, press and HOLD  and  buttons simultaneously while the display flashes three times. The new selection is then displayed.
- Press any key to return to normal operation.
- Displayed wind speeds using PRO calibration will include tenths of units (ex: 10.5), where wind speeds using Std calibration will be display as whole numbers (ex: 10).

IMPORTANT NOTE CONCERNING UPGRADES:

If you have upgraded your weather station by adding a new *ULTIMETER* 800 keyboard/display, but are still using an earlier anemometer (with 1.2-inch cups), you must select the Standard ("Std") calibration in order to properly measure wind speeds.

7. Check all receptacles for crossed wires (see illustration below). This can occur during plug-in and unplugging of the cables. It can be corrected by using a pair of tweezers to gently lift the wire back into the correct slot.

WRONG

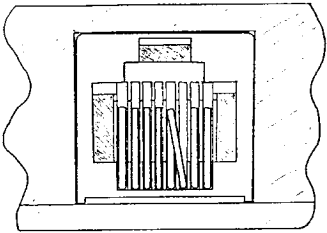

RIGHT

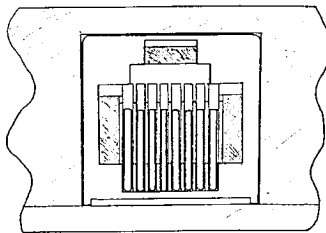

8. Without uncoiling the cables, plug the wind vane cable and the temperature cable into the junction box, in accordance with the markings on top of the junction box.



NOTE: If you have ordered any extension cables, do not uncoil them, but insert each between the junction box and the thermometer or anemometer/wind vane, just as it will be used in your actual installation.

9. Uncoil the 8-ft. junction box cable and plug one end into the receptacle on the back of the keyboard/display unit. Plug the other end into the junction box, opposite the temperature cable.

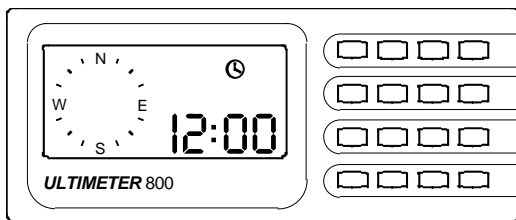
10. Plug the AC adapter cable into the junction box, then plug the adapter itself into a 110-volt 60-cycle outlet. After 2 or 3 seconds, the liquid crystal screen will come on, displaying the clock symbol, "12:00" and the compass rose for wind direction, as shown below.





Test Anemometer/Wind Vane Functions

1. Press and release the wind speed key, marked , to display current wind speed. Press and release it a second time to display wind direction in degrees° (N=0°, E=90°, S=180°, W=270°, etc.)
2. If you wish to display wind speed in units other than mph, press  again and keep it pressed. The screen will flash 3 times, then display wind speed in m/s. Each time you repeat the procedure, wind speed will be displayed in alternate measurement units; mph, m/s, knots, or km/h.
3. Blow gently and steadily on the anemometer cups, so they rotate clockwise when viewed from above and the screen displays a fairly steady wind speed of 3.0 mph or more (4.8 km/h or 2.6 knots). Stop blowing when a wind direction arrow is displayed within the compass rose. The wind direction is calculated only while the anemometer cups are spinning. This prevents any false indication of the last wind direction.
4. Point the wind vane in the opposite direction. Again blow gently and steadily on the cups. The wind direction arrow will shift to the opposite side of the compass rose.
5. Now blow on the cups a little harder, until the reading increases, then let the cups stop.
6. Press the up key, which is marked . The screen will display the highest wind speed registered while you were blowing on the cups. The direction in degrees (of the highest wind) and the time and date at which the high wind speed occurred will be alternately displayed (see "Displaying Stored Data" section for complete information). Don't worry that time and date are not yet correct - we'll be setting them in "Initial Adjustments" instruction section.

NOTE: The *ULTIMETER* 800 does not display a low wind speed value, simply because zero is normally the lowest wind speed measured.

7. Press any function key to exit the highest value display.

Test Temperature Functions

1. Press and release the temperature key, which is marked  on the keyboard/display unit. The screen will display current temperature in degrees Fahrenheit and a thermometer symbol.
2. Press  again and keep it pressed. The screen display will flash 3 times, and then display the temperature in degrees Celsius. Release the key. Repeat this procedure until the units you intend to use are

displayed. Each time you repeat this procedure, temperature will be displayed in alternate units, Celsius or Fahrenheit.

3. Hold the temperature sensor in your hand for 2 or 3 minutes. The temperature indicated on the screen will rise.
4. Release the temperature sensor and allow the indicated temperature to come back down several degrees.
5. Press the up key, which is marked . The screen will display the date, highest temperature registered, and time it occurred, while you were holding the sensor.
6. Press any function key to exit the highest value display. When you are entirely satisfied with the instrument's performance, you are ready to proceed.
7. Unplug the junction box cable from the back of the keyboard to erase test readings from memory.

III. PLANNING YOUR INSTALLATION

Please take a few minutes to plan the installation of your home weather station. You'll help assure your long term satisfaction with the installation and almost certainly save time and effort in the process.

It may be helpful to remember that the cable lengths are:

Wind Sensor: 40 feet	Temperature Sensor: 25 feet
Rain Gauge (Optional): 40 feet	Junction Box Cable: 8 feet
AC Adapter Cord: 6 feet	Indoor Humidity Sensor: 20 feet
Outdoor Humidity/Temperature Sensor: 40 feet	

First you must decide where each system component is to be installed. We suggest that you determine the optimum location of the prime components in the order shown below.

Control Unit Location - The primary considerations in placement of the Keyboard/Display unit are: which room it should go in, and should it be wall mounted or desk mounted.

Room Selection

- in which room will the data be most useful (e.g. bedroom, kitchen, hallway near hall closet, solarium, etc.);
- in which room will the most people be able to enjoy and use the data (e.g. living room or family room);
- other factors being equal, which room will make for easiest wiring.

Wall Mount Advantages

- better visibility from most of the room;
- wiring can often be completely concealed -- may offer shorter wire runs to outside sensors, possibly avoiding the need for extension cables.

Desk Mount Advantages

- convenient access to keyboard;
- optimum visibility from desk chair;
- convenient for connection to a Personal Computer.

Anemometer/Wind Vane Location - The anemometer/wind vane is designed to clamp to the top 3.5 inches of a mast having a diameter of at least 1 in. and not more than 1-1/4 in. A thin-wall steel TV antenna mast is ideal (available at Home Depot, Radio Shack and many other stores).

NOTE: DO NOT MOUNT THE WIND SENSOR DIRECTLY ON TOP OF IRON PLUMBING PIPE OR EMT ELECTRICAL CONDUIT. Pipes and conduit have relatively thick ferrous (magnets will stick to them) walls, which can interfere with the proper operation of the magnets in the anemometer/wind vane.

If you wish to use iron pipe or electrical conduit as a mast, simply add a short section of PVC to the top and clamp the wind sensor onto the PVC. There are many ways to do this, but two typical methods are:

- a. If you are using a 3/4 inch iron water pipe as a mast, screw a PVC pipe adapter with a 6-inch piece of 3/4 inch Schedule 40 PVC pipe onto the top of your mast.
- b. If you are using 1-inch EMT electrical conduit as a mast, just press a 12-inch long piece of 3/4 inch Schedule 40 PVC pipe six inches into the top of the conduit.

In either method, PVC should not be used for the entire mast because the **MAST MUST BE GROUNDED**. In addition, PVC pipe is not strong enough to be used as a mast without reinforcement.

Considerations for locating the mast:

- use an existing TV or FM-type mast if you can.
- mast should extend at least 3 feet (more if possible) above the highest part of your roof or other nearby obstruction. You may be able to add an extension to an existing mast.
- the mast should, as nearly as possible, be exactly vertical.
- the top 3-1/2 in. of the mast must be free. Again, you may be able to add a short extension to an existing mast.
- if you are installing a new mast, it will be most economical to locate it within 40 ft. of the junction box, so you won't need an extension cable.
- mast must not be mounted on, or directly next to, an active chimney. Flue gasses are very corrosive.

CAUTION: MAKE SURE THE MAST YOU USE IS PROPERLY GROUNDED. IF YOU HAVE ANY DOUBT, HAVE IT CHECKED BY A QUALIFIED TV SERVICE PERSON.

Temperature Sensor Location

NOTE: Before drilling holes and permanently installing the temperature sensor, you may wish to experiment with the temperature sensor location to be sure of satisfactory readings.

Generally speaking, you should locate the temperature sensor:

- in the shade where it can never receive direct sunlight
- protected from wind and rain
- where air can circulate freely around it (e.g. avoid closed gable ends that can trap a pocket of warm air)
- away from incidental heat sources, such as roof circulation vents
- not directly above radiated or reflected heat sources such as cement patios or large picture windows
- so that the last three feet of cable (or more) are outside the structure in the open air
- so that the cable, rather than the sensor itself, is secured by the supplied mounting clamp

It is surprising how much these factors affect temperature readings; we have seen errors of 4° to 6° caused by just one of these factors.

Outdoor Humidity/Temperature Sensor (Optional) Location

The considerations for locating the outdoor humidity sensor are the same as for the external temperature sensor except for the mounting clamp referred to above. The Humidity/Temp Sensor is mounted using the included screws (2) and stand-off spacers (2). Be sure to use the spacers.

Indoor Humidity Sensor (Optional) Location

Generally speaking, the indoor humidity sensor should be located:

- where it does not receive direct sunlight
- where air can circulate freely around it
- not in the direct airflow from furnace or air conditioning duct
- where humidity monitoring is most important, such as in the room of a person with heart or respiratory problems, in a solarium, in a wine cellar, or even where rare books or antiques are kept.

Rain Gauge (Optional) Location

- in the open, away from overhanging trees

- well clear of the house or other structures that might block blowing rain
- easily accessible for periodic inspection and cleaning
- **DO NOT locate on high tower** or inaccessible rooftop!

Junction Box Location

- must be indoors
- must be close to an ac outlet, so the ac adapter cord can reach it
- a vertical orientation is preferable to minimize the possibility of dust getting into the junction box
- consider connecting serial data peripherals such as a PC or Weather Picture to the Junction Box's "i/o" port

If you will not require extension cables (that is, if the external sensors are each close enough to the control unit location) it is usually best to locate the junction box within 8 feet of the control unit.

Extension Cables

There is no problem extending the anemometer/wind vane cable or optional rain gauge cable to 250 feet or more. Be sure the extension cable used is correctly wired - if in doubt, proper 40' Extension Cables may be obtained from Peet Brothers Company.

The Outdoor Humidity/Temperature Sensor cable length should be kept as short as practical, but extension up to 100 feet will not degrade performance.

Normally it is best not to extend the total cable length from the temperature sensor to the keyboard display unit any more than necessary. Longer cables tend to decrease the temperature reading slightly. For example, a total length of 265 feet (using six 40-foot extension cables) can decrease temperature readings about 1.5°F. This applies only to temperatures above about 60°F; measurements of temperatures below 60°F are unaffected by long cable lengths.

Instead of extending more than one sensor cable, it may be possible and more economical to place the junction box further from the keyboard/display unit, using a 40' Junction Box Extension Cable.

NOTE: If you plan to use a sensor extension cable that will be joined outside, you must waterproof the connection.

IV. INSTALLING YOUR *ULTIMETER 800* COMPONENTS

Installing the Anemometer

1. Slide the locking ring up as far as it will go on the fingers.
2. Place the anemometer/wind vane over the top of the mast with all four fingers on the outside of the mast.
3. Slide the clamping ring down over the fingers until you start to feel significant resistance.
4. Find the North Calibration Mark on the anemometer (this is the small silver line located near the screw head - see illustration below). Rotate the anemometer on the mast until the calibration mark is facing due north. Use a compass or other directional reference.

Tip: Use a piece of tape to hold the wind vane pointed in the direction of the silver mark, and use the wind vane pointer to help to install the anemometer in the correct position. Rotate the anemometer on the mast until the wind vane points North (remember to remove tape!).

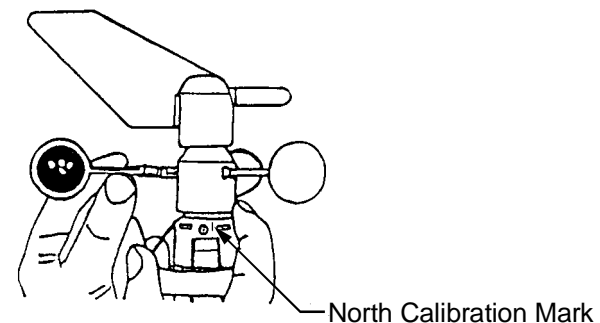

5. Firmly clamp the anemometer in place by repeatedly pulling the locking ring down, first a little on one side, then a little on the opposite side, keeping it more or less level, until you can't pull it down any further.
6. Using the cable ties provided, secure the cable to the mast. One tie should be placed just about 2 in. below the anemometer/wind vane. The other two should be evenly spaced below that.

Installing the External Temperature Sensor

1. Drill a pilot hole at the desired location.
2. Mount the supplied clamp and temperature sensor taking care that its protective metal housing does not touch any nearby surface. The metal end should be pointed "up", with the cable exiting downward, to discourage water droplets or ice from "hanging on" to the metal housing.

Installing the optional Outdoor Humidity/Temperature Sensor

1. Drill two pilot holes 6 in. apart at the desired mounting location.
2. Place the two stand-off spacers (provided) under the sensor's mounting flanges, between the wall and the back of the sensor.
3. Mount the sensor, using wood screws (provided) for a wooden wall or drywall anchors (provided) for a concrete wall.

Installing the optional Indoor Humidity Sensor

1. Drill two pilot holes 6 in. apart at the desired mounting location.
2. Mount the sensor, using wood screws (provided) for a wooden wall or drywall anchors (provided) for a sheet rock wall.

Installing the Keyboard/Display Unit

Desk or Shelf Mounting

1. Assemble the desktop stand as shown below.

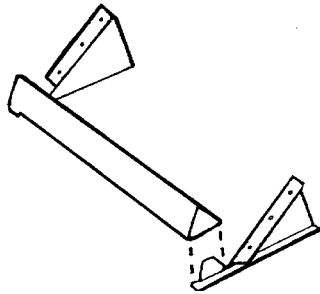

2. Place the keyboard/display unit on the stand so the two alignment pins on the stand fit firmly into the matching holes on the back of the instrument.
3. Secure the Keyboard/display unit to the stand, using the two screws provided.
4. Insert the plug of the junction box cable into the back of the control panel. Be sure it "clicks" into place.

5. Position the assembled unit as desired.

Wall Mounting

1. Using the mounting bracket as a template, use a pencil to mark two holes 3.75 in. apart for the wood screws or drywall anchors provided. Mount at a height slightly above eye level for best viewing angle.
2. Install the mounting bracket using the two screws provided. Do not overtighten.

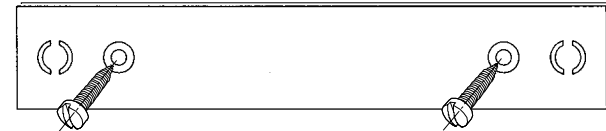

3. Insert the plug of the junction box cable into the back of the control panel. Be sure it "clicks" into place.
4. If the junction box cable is to run down the wall, insert the cable into the groove provided on the back of the keyboard/display unit.
5. Hang the keyboard/display unit from the two projecting nubs on the mounting bracket.

Installing the Junction Box

1. Drill two pilot holes 3-1/2 in. apart at the desired mounting location.
2. Mount the junction box; use wood screws (provided) for a wooden wall or drywall anchors (provided) for a sheet rock wall.
3. Plug in cables from the ac adapter, keyboard display unit, thermometer, anemometer/wind vane, and rain gauge, also PC or Weather Picture if applicable.

V. CONNECTING THE *ULTIMETER 800* SYSTEM



Connect components to configure your system as shown in the Wiring Diagram.

Notes concerning Unimounts: If your system includes a Unimount Sensor Array (optional), please refer to the wiring diagram provided with the Unimount. Also, in Unimount systems, The Weather Picture® **MUST** be connected to the serial data port of the *ULTIMETER 800* keyboard using an adapter cable, and cannot be connected to the junction box.



Using the following sequence, apply power to your system:

1. Plug one end of the 8-conductor cable into the junction box. Plug the other end into the back of the instrument.
2. Connect the AC adapter into an AC outlet. In 110 volt systems, be sure to use the 3-prong AC adapter and a properly grounded 3-prong outlet. Then, plug the AC adapter output cable into the junction box. Allow 2 or 3 seconds for the keyboard display to come on.
3. Install a fresh 9 volt back-up battery (not included) at this time, in order to preserve any settings or adjustments that you make while installing the system.

The back-up battery compartment is located on the lower right side of the keyboard/display unit. To open the compartment, slide the cover in direction of arrow. Insert a 9-volt battery, with the + and - terminals oriented as shown in the diagram on the back of the keyboard housing. Replace the cover.

4. Press  and  simultaneously to initiate the battery check function. In a few seconds, the flashing battery symbol should go out.

About the Battery Symbol in the Display

In operation, a flashing battery symbol indicates a weak battery in need of replacement. Your keyboard automatically performs a battery check daily. To perform a battery check manually, press  and  simultaneously to initiate the battery check function. In a few seconds, the flashing battery symbol should go out. If it does not, the battery should be replaced.

WIRING DIAGRAM

Connect components to Junction Box as shown in diagram below.

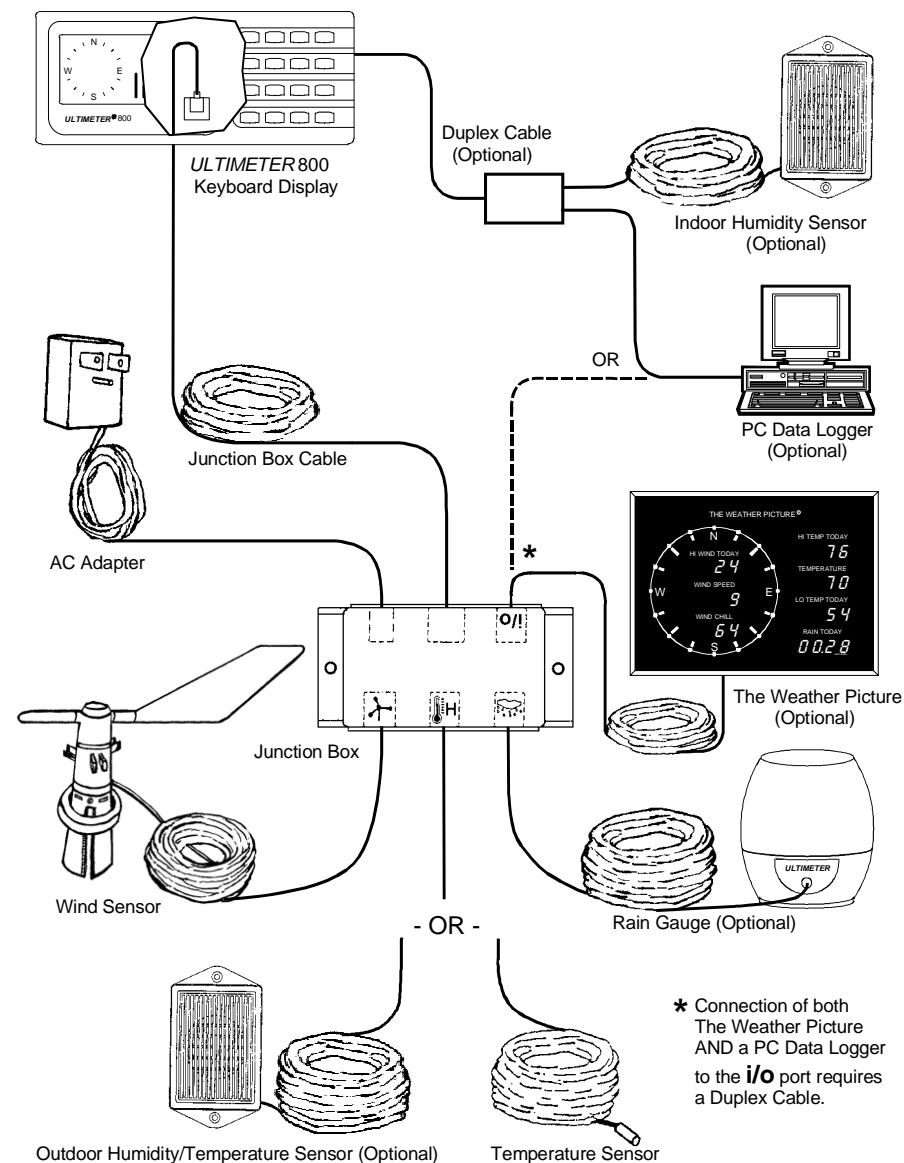





NOTE: The Weather Picture® requires a 12v/1000mA AC Adapter be used in place of the 12v/400mA AC Adapter supplied with the *ULTIMETER 800*. Also, **BEFORE YOU INSTALL PLUGS IN RECEPTACLES**, be sure to check connectors as shown on p. 13.

VI. INITIAL SETTINGS

SET THE YEAR









This instrument features a perpetual calendar, using a leap year counter to keep track of each leap year. For it to operate correctly, you must set the current year before you set the day and month.

1. Press and release  and  simultaneously. The clock and calendar symbols will appear on the screen and the instrument will display the year setting (default is 2009).
2. Press  and KEEP IT PRESSED until the year begins to change. Then press  or  as required until the display shows the current year.



NOTE: It's best to set the Year BEFORE you set the date. If you have already set the date, check it after setting the year, and adjust the date display as necessary.

NOTE TO SERIAL PORT USERS: It is essential to make the correct Year setting; otherwise, date data from the serial port may be incorrect.

SET DATE AND DATE FORMAT

1. Press and release . The date will be displayed in mm/DD format. If this is satisfactory, you may skip to Step 3.
2. If you prefer a DD/MM date display, press and hold  until the display stops flashing (the display will flash three times, then change to DD/mm format). To change back to MM/DD format, repeat the procedure.
3. Press and hold the  for at least three seconds. The date display will flash three times, then enter a setting mode and the date will begin to change. Press  or  as required to set the correct date. If you press and hold  or , the display will change rapidly.
4. When you have finished setting the date, press  to return to normal operation.









RESET LONG-TERM MEMORIES

Press and hold  and  simultaneously for at least three seconds. The display will flash three times, then stop. All Long

Term high and low values will be replaced by the current values, the Long Term rainfall total will be reset to zero, and the rainfall "since" date will be reset to the current date.



You may wish to use this "master reset" procedure on the first day of each new month. All Long Term high and low values will then be the highest and lowest values, and also the total rainfall, for the month to date.

SET TIME AND TIME FORMAT

1. Press the  key.
2. If you prefer a 24-hour clock display, press  again and hold until the display stops flashing (the display will flash three times, then change to 24-hr format). To change back to 12-hr format, repeat this procedure.
3. Press and hold  for at least 3 seconds. The time display will flash three times, then enter a setting mode and the time will begin to change. Press  or  as required to set the correct time. If you press and hold  or , the display will change rapidly.
4. Press  to return to normal operation.

SELECT TEMPERATURE UNITS



Temperature is initially displayed in degrees Fahrenheit. Use the following procedure if you prefer degrees Celsius.

1. Press and release the  key.
2. Press  again and hold until the display stops flashing. Temperature will be displayed in Celsius. To return to Fahrenheit, repeat this step.

NOTE: Units for wind chill , dew point , and heat index will be the same as for temperature.

SELECT WIND SPEED UNITS

Wind Speed is displayed initially in mph. You may select m/s, knots, or km/h as preferred.

1. Press and release the  key to display current wind speed.
2. Press  again and hold until the display stops flashing. Wind speed will be displayed in m/s.
3. Repeat this procedure to select knots or km/h.

SELECT RAIN GAUGE INCREMENTS AND RAINFALL UNITS

If your *ULTIMETER* system does not yet include a self-emptying rain gauge, you may skip this section and proceed to "DISPLAYING CURRENT DATA".

Use the procedure below to tell the instrument the measuring increment of your rain gauge. Allowable rainfall increments are: 0.01 inches, 0.25 mm, 0.1 inches, 0.1 mm, and 2.5 mm.

1. Press and release the  key. The rain icon and "0.00 in" will appear in the display. Each time your rain gauge reports an increment of rain, the rain display will increase by 0.01 inches. If your rain gauge reports rainfall in increments of 0.01 inches, skip the rest of this section.

2. Press and hold the  key a second time until the display stops flashing. "0.00 mm" will appear in the display. Each time your rain gauge reports an increment of rain, the rain display will increase by 0.25 mm. If your rain gauge reports rainfall in increments of 0.25 mm, skip the rest of this section.



3. Press and hold the  key a third time until the display stops flashing. "0.0 in" will appear in the display. Each time your rain gauge reports an increment of rain, the rain display will increase by 0.1 inches. If your rain gauge reports rainfall in increments of 0.1 inches, skip the rest of this section.



4. Press and hold the  key a fourth time until the display stops flashing. "0.0 mm" will appear in the display, with the "mm" flashing. Each time your rain gauge reports an increment of rain, the rain display will increase by 0.1 mm. If your rain gauge reports rainfall in increments of 0.1 mm, skip the rest of this section.

Note to Serial Data Port Users: when you select 0.1mm increments, the serial data output will report rain totals in metric rather than English units.

5. Press and hold the  key a fifth time until the display stops flashing. "0.0 mm" will appear in the display, with the "mm" not flashing. Each time your rain gauge reports an increment of rain, the rain display will increase by 2.5 mm. If your rain gauge reports rainfall in increments of 2.5 mm, this is the correct setting.

INITIALIZE THE LONG-TERM RAINFALL TOTAL





Press and release the  key. Then press and release the  key eight times to display the long-term rainfall. Press and hold







 for at least three seconds. The display will flash three times, then stop. The Long Term rainfall total will be reset to today's rainfall, and the rainfall "since" date will be reset to the current date. Or, to reset ALL long-term memories (including rainfall), press and hold  and  simultaneously for at least three seconds. The display will flash three times, then stop. All Long Term high and low values will be replaced by the current values, the Long Term rainfall total will be reset to today's rainfall, and the rainfall "since" date will be reset to the current date. You may wish to use this "master reset" procedure on the first day of each new month.

TO ADJUST THE LONG-TERM RAINFALL TOTAL



If you wish to include rainfall accumulated prior to installation of your *ULTIMETER 800*, you must adjust the long-term rainfall memory to display the accumulated total rainfall, and also adjust the rainfall "since" date to reflect the earlier beginning of your rainfall record. If the "since" date on your weather station is already correct, then perform only Step 3. Otherwise, perform all four steps.

Step 1: Adjust the rainfall "since" date as follows:



a) Enter the year of the "since" date, by pressing and releasing  and  simultaneously. The instrument will display the year setting (default is 2009). Press  and KEEP IT PRESSED until the year begins to change. Then press  or  as required until the display shows the correct year of the rainfall "since" date.



b) Enter the day and month of the "since" date, as follows: press and release  to display date. Press and hold  for at least three seconds. The date display will flash three times, then enter a setting mode and the date will begin to change. Press  or  as required to set the correct date. If you press and hold  or , the display will change rapidly.

Step 2: Reset the Long-Term Rain total and "Since" date as follows:

Press and release the  key. Then press and release the  key eight times to display the long-term rainfall. Press and hold  for at least three seconds. The display will flash three times, then stop. The long-term rainfall total will be reset to today's rainfall, and the rainfall "since" date will be reset to the date you input in step 1.

Step 3: Enter the desired Long-Term Rainfall total as follows:









1. Press and hold  and  simultaneously for at least three seconds until the displayed long-term rainfall total begins to change.

2. Then press  or  repeatedly until the desired rainfall total is displayed (be sure to include today's rainfall in your long-term total). Press  to return to normal operation.

Step 4: Reset to the Current Date (enter current year, then current day and month), by following the key sequences of Step 1.



VII. DISPLAYING CURRENT DATA

TO DISPLAY THE CURRENT VALUE OF WIND SPEED, WIND CHILL, OUTDOOR TEMPERATURE, OUTDOOR HUMIDITY, DEW POINT (OUTDOOR), TIME, OR DATE:



Press and release the desired data key: , , , , , , or . The corresponding symbol will appear on the screen and the current data value will be displayed. To display current Wind Direction in Degrees, press  twice (you may press again to return to Wind Speed).



NOTE: When you press  or , the instrument will display the outdoor temperature or outdoor humidity.

TO DISPLAY CURRENT WIND DIRECTION IN DEGREES





The current wind direction in degrees ($^{\circ}$) is displayed by pressing the  key twice (the first press displays the current wind speed): N=0 $^{\circ}$, E=90 $^{\circ}$, S=180 $^{\circ}$, W=270 $^{\circ}$, etc. Pressing the  key again returns the display to the current wind speed.

TO DISPLAY CURRENT INDOOR TEMP OR HUMIDITY

1. Press and release  to display outdoor temperature or  to display outdoor humidity.

2. Next, press and release  to change display from outdoor reading to indoor reading. The  symbol will appear in the display and the current indoor value will be shown.

TO DISPLAY CURRENT HEAT INDEX TEMPERATURE





The current Heat Index Temperature is displayed by pressing the  key twice (the first press displays the current dew point temperature). The  and  symbols will alternately flash in the display to indicate heat index. Pressing the  key again returns the display to the current dew point.

Automatic Scanning

The instrument can continually scan any of the following data at 5-second intervals:

Wind Speed	Today's Rainfall
Wind Chill	Time
Temperature (Indoor & Outdoor)	Date
Dew Point	
Humidity (Indoor & Outdoor)	

To select data to be scanned:

1. Press  and keep it pressed until "SEL" (select) appears in the display.
2. Press the data key of each function you wish to include in the scan sequence. Remember to press  following  or  if indoor temperature or humidity are desired.
3. Press  to end the selection process and start the scan.

To exit scan mode, press any data key.

To resume scanning, press and release .

VIII. *ULTIMETER* 800 HIGH/LOW MEMORY SYSTEM

The *ULTIMETER* 800 keyboard monitors and displays current data from eight different sensors (plus calculated wind chill temperature). It also maintains nine memory banks for high and low records. The instrument will be most valuable to you if you understand the nine memory banks:

TODAY'S HIGHS, LOWS, AND RAINFALL

At midnight each night, the *ULTIMETER* 800 starts keeping track of high and low values, and rainfall, for the new day. At any time during the day, the instrument can tell you what the highest and lowest values have been, thus far in the day (since midnight). "TODAY'S" high and low values are automatically maintained, and cannot be manually altered or reset. If you ever wish to record highs and lows, or rainfall, starting from a specific time, you may use the user-resettable "Long Term" high/low memory described below.

PREVIOUS DAY'S HIGHS, LOWS, AND RAINFALL

Each midnight the instrument moves TODAY'S highs and lows and rainfall into separate memory, now calling them PREVIOUS DAY'S values. At any time in the current day, you can retrieve the high and low values and rainfall for each of the previous seven days - directly from the keyboard or remotely by phone, modem, or radio link. PREVIOUS DAY'S values are automatically maintained, and cannot be manually altered or reset. If you ever wish to record highs and lows or rainfall starting from a specific time, you may use the user-resettable "Long Term" high/low memory described below.

LONG TERM HIGHS AND LOWS





The long-term memory bank is extremely flexible. It keeps track of highest and lowest readings, and accumulated rainfall, since the last time you reset the stored value. You can individually reset any high or low value in this memory whenever you wish. For example, you may wish to keep close watch on a major storm by resetting the LONG TERM highest wind speed memory, or the LONG TERM rainfall total just before the storm hits, or even again during the storm.

There is also a master reset that resets all of the LONG TERM stored values simultaneously. If you wish to track monthly highs and lows, just use the master reset at the beginning of each new month.



IX. DISPLAYING STORED DATA

TO DISPLAY HIGHEST VALUES

To display the highest values of wind speed, temperature, or humidity for today, yesterday, and long term:

1. Press the desired data key to display the current value.
2. To display TODAY'S highest value (since midnight), press  once. The display will repeatedly cycle through today's date, today's high value, and the time at which it occurred.
3. To display PREVIOUS DAY'S highest values (from midnight to midnight), press  again, repeatedly, to display the values for each of the LAST SEVEN DAYS. After each press, the display will repeatedly cycle through: the selected date, that day's high value, and the time at which it occurred.
4. To display the LONG TERM highest value (since last RESET), press  a ninth time. The display will repeatedly cycle through: the date on which the highest value occurred, the highest value since last reset, and the time at which it occurred. The Long Term high value is the highest value recorded since you last reset this memory. The Long Term display is easily recognized by the flashing  when the date is displayed.
5. Pressing  a tenth time returns the display to TODAY'S highest value.

TO DISPLAY LOWEST VALUES





1. Press the desired data key to display the current value.
2. To display TODAY'S lowest value (since midnight), press  once. The display will repeatedly cycle through today's date, today's low value, and the time at which it occurred.
3. To display PREVIOUS DAY'S lowest values (from midnight to midnight), press  again, repeatedly, to display the values for each of the LAST SEVEN DAYS. After each press, the display will repeatedly cycle through: the selected date, that day's low value, and the time at which it occurred.
4. To display the LONG TERM lowest value (since last RESET), press  a ninth time. The display will repeatedly cycle through: the date on which the lowest value occurred, the lowest value since last reset, and the time at which it occurred. The Long Term low

value is the lowest value recorded since you last reset this memory.

The Long Term display is easily recognized by the flashing  when the date is displayed.

5. Pressing  a ninth time returns the display to TODAY'S lowest value.

TO DISPLAY RAINFALL

1. To display TODAY'S rainfall (thus far since midnight), press . The instrument will display today's total rainfall.
2. To display PREVIOUS DAY'S rainfall (from midnight to midnight) press , repeatedly, to display daily rainfall for each of the LAST SEVEN DAYS. The display will alternate between the selected date and that day's total rainfall.
3. To display the LONG-TERM ACCUMULATED rainfall (since you last reset this value to zero), press  an eighth time. The display will alternate between the date you last reset this total and the rainfall accumulation since that date.
4. Pressing  a tenth time returns the display to TODAY'S rainfall.

X. RESETTING LONG TERM MEMORY VALUES



TO RESET A SINGLE LONG TERM HIGH OR LOW MEMORY

NOTE: Only Long Term memory values can be reset; you cannot clear Today's or Previous Day's values. These are automatically reset (updated) by the instrument.

1. First, display the stored Long Term data you wish to clear.
2. Press and hold the  key for at least three seconds. The display will flash three times, then change to a display of the current value, the current time, and today's date.

TO RESET ALL LONG TERM HIGH, LOW, & RAIN MEMORIES

Instead of resetting each Long Term high and low memory individually, you may simultaneously reset all Long Term highs and lows, including the Long Term rainfall total. To do so:

Press and hold  and  simultaneously for at least three seconds. The display will flash three times, then stop. All Long Term high and low values will be replaced by the current values, and the Long Term rainfall total will be reset to zero.

You may wish to use this "master reset" procedure on the first day of each new month. All Long Term high and low values will then be the highest and lowest values for the month to date.











TIP: If you always use only the master reset (as opposed to individual resets), the date shown on the Long Term rainfall display will be the date when all highs and lows were last reset.

XI. ALARMS

The *ULTIMETER* 800 includes the following 15 adjustable alarms: High Wind Speed, High Outdoor Temperature, Low Outdoor Temperature, High Indoor Temperature, Low Indoor Temperature, Low Wind Chill Temperature, High Outdoor Humidity, Low Outdoor Humidity, High Indoor Humidity, Low Indoor Humidity, Flash Flood Alert, and Time Alarm.

When an alarm setting is exceeded, the display flashes the alarm setting and a high-pitched alarm will sound. The sound will stop automatically after about 30 seconds, but the display will continue flashing until reset.

TO SET AN ALARM (other than Flash Flood Alert)

1. Select the function for which you wish to set an alarm by pressing , , , , or  (for indoor temperature or humidity, next press ). If you are setting an alarm for wind speed, wind chill, or time, skip to step (3).
2. This instrument has both a high and a low alarm for temperature and humidity. Press  to set a high alarm or  to set a low alarm.
3. Press and release  to display the current alarm value.
4. Press and hold  or  until the display changes, then press repeatedly until desired alarm setting is displayed.

THE RAIN RATE ALARM







This instrument provides a rain rate alarm, intended for use where there is danger of local flooding or downstream flash flooding. Flash flooding can result when heavy rainfall occurs at higher elevation, and water rushes toward low-lying areas. The rain rate alarm warns that heavy rainfall has occurred, which could result in impending local flood conditions, or flash flooding within your vicinity (or possibly downstream, outside of your vicinity). Bear in mind that your success in predicting flash flooding depends upon many factors, in addition to rain rate: terrain, elevation, drainage, etc.

Before setting the rain rate alarm, be sure to select rainfall units according to the type of rain gauge you are using.







The rain rate alarm is set in inches-of-rain or mm-of-rain per hour. An alarm will sound of a specified minimum amount of rain (called the threshold) falls at a rate equal to or greater than the rain-rate setting. The default threshold value is 0.5 in, or 12.7 mm.

EXAMPLE: If you set an alarm for a rain rate of 2 inches per hour, the alarm will sound if 0.5 inches of rain (the default threshold value) falls within 15 minutes, which equals an hourly rate of 2 inches per hour.

To adjust the Rain Rate Alarm rain rate:

1. Press and release .
2. Press . The rain, clock, and alarm symbols will appear in the display, and the present rain rate alarm setting will be displayed.
3. Press and hold  or  until a value is shown and begins to change. The rain rate can be adjusted from 0.1 in/hr to 10 in/hr in 0.1-in increments, or from 2.5 mm/hr to 254.0 mm/hr in increments of 2.5 mm/hr.
4. Press  or  repeatedly until the desired rain rate setting is shown.

To adjust the Rain Rate Alarm threshold value:

1. Press  and  simultaneously. The rainfall and alarm symbols will appear in the display, and the present threshold value will be shown.
2. Press and hold  or  until the threshold value begins to change. The threshold value can be adjusted from 0.1 inch to 0.5 inch in 0.1-inch increments, or from 2.5 mm to 12.5 mm in increments of 2.5 mm.
3. Press  or  repeatedly until the desired threshold value is shown.

TO MOMENTARILY STOP AN ALARM FROM SOUNDING

With the alarm setting displayed, press the  key. The alarm sound will stop temporarily. When you return to normal operation (displaying data), the alarm will sound again when the current value exceeds the alarm setting.

TO DISABLE AN ALARM

First, display the alarm setting. If the alarm has been triggered, the alarm setting will already be displayed.

Then, press and hold the  key for at least three seconds. The display will flash three times, then read "OFF".

FCC STATEMENT ON CLASS B

This equipment has been tested and found to comply with the limits for a Class B digital device, pursuant to Part 15 of the FCC rules. These limits are designed to provide reasonable protection against harmful interference when the equipment is operated in a residential installation. This equipment generates, uses, and can radiate radio frequency energy and if not installed and used in accordance with the instruction manual may cause harmful interference to radio communications. However, there is no guarantee that interference will not occur in a particular installation. If this equipment does cause harmful interference to radio or television reception, which can be determined by turning the equipment off and on, the user is encouraged to try to correct the interference by one or more of the following measures:

- Reorient or relocate the receiving antenna.
- Increase the separation between the equipment and the receiver.
- Connect the equipment into an outlet on a circuit different from that to which the receiver is connected.
- Consult the dealer or an experienced radio TV technician for help.



Notice: The changes or modification not expressly approved by the party responsible for compliance could void the user's authority to operate the equipment.

XII. THE ULTIMETER 800 SERIAL PORT

The *ULTIMETER* 800 provides a unique 7-mode serial port to facilitate computer data logging and remote data reporting via telephone, modem, or RF link. Each of the four modes can be accessed by pressing and holding a combination of two keys, or by command into the serial port. The following is a brief description, to provide an idea of the capabilities of each mode. The serial port is located in the Junction Box (receptacle "i/o") and also the right-side receptacle of the keyboard/display. Complete details are available to programmers upon request or at www.peetbros.com.

WEATHERTEXT OUTPUT MODE

In WeatherText Output Mode, the instrument puts out one human-readable (text) Weather Report each minute. The serial text output is viewed on the monitor of a PC using terminal software such as HyperTerminal (located on your Windows PC at Start/Programs/Accessories/Communications/HyperTerminal), or using **WeatherText™ Tools** software from Peet Bros. The text output may be "captured" and saved as a .txt file for later viewing or printout. Communications settings are 2400/8/N/1 (contact Peet Bros. Tech Support for further assistance). Each "WeatherText Report" includes all current values, plus the highest wind speed over the past minute with the associated wind direction, the average wind speed over the last minute, today's and long-term rainfall, today's highs and lows, and current time and date. Key Combo:

Press and hold  and  for 3 seconds to enter this mode. In addition, each time this key combo is pressed, a comprehensive "Complete History Report" is output (contains highs and lows for the previous 7 days plus long-term). Following is a sample WeatherText Report:

```
ULTIMETER WEATHER REPORT 01/17/05 09:32A
Wind:      Cur 11.4MPH 180Deg, 1mAvg 0.0MPH, 1mPeak 16.3MPH 166Deg
           Hi 19.1MPH 176Deg
WChill:    Cur 75.7F, Lo 45.6F
Temp Out:  Cur 75.7F, Hi 75.7F, Lo 55.6F
Temp In:   Cur 76.4F, Hi 72.6F, Lo 72.3F
Hum Out:   Cur 65.6%, Hi 85.9%, Lo 65.6%
Baro:      Cur 29.93i nHg, Hi 30.14i nHg, Lo 29.93i nHg, 3hr chg -0.09i nHg
Dewpt:     Cur 63.6F
Heatx:     Cur 77.0F
Rain:      Today 0.12i n, Since 01/01/05: 0.34i n
```



WeatherText™ Tools software also generates an APRS data string for ham radio transmission (ref. **WeatherText™ Tools** "Help" for more info).

COMPLETE RECORD MODE

Recommended for use with The Weather Picture®



In Complete Record Mode, the instrument puts out a steady stream of records, about thirty per minute. Each record includes all current values, today's high and low values, yesterday's high and low values, and long term high and low values, station calibration

numbers, and current time and date. Key Combo: Press and hold

 and  for 3 seconds to enter.

DATA LOGGER MODE

In Data Logger Mode, the instrument puts out a steady stream of records, about two per second. Each record includes all current readings including time and date. Key Combo: Press and hold

 and  for 3 seconds to enter this mode.



PACKET MODE

In Packet Mode, the instrument puts out one record every five minutes. Each record includes all current values, plus the highest wind speed over the past five minutes with the associated wind direction, station calibration numbers, and current time and date.

Key Combo: Press and hold  and  for 3 seconds to enter this mode.



COMPLETE HISTORY MODE

In Complete History Mode, the instrument puts out a steady stream of records, about twelve per minute. Each record includes all current values, today's high and low values, seven previous day's high and low values, long term high and low values, station calibration numbers, current time, date, and year. Key Combo:

Press and hold  and  for 3 seconds to enter this mode.



MULTIPLE OUTPUT MODE

Recommended for use with The Weather Picture®

In Multiple Output Mode, the instrument puts out a stream of consecutive records, alternating between each of the four output modes described above. WeatherText Mode, Complete Record Mode, Complete History Mode, and Data Logger Mode records are output continuously; in addition, a Packet Mode record is output every five minutes. This mode enables multiple serial data output applications requiring different output modes. Key Combo: Press and hold  and  for 3 seconds to enter this mode.

MODEM MODE





In Modem Mode, the serial port is kept in a receive mode with no data output. It will accept commands to send a Complete Record, set time and date, set wind direction correction, set temperature and humidity offsets, and reset all long term memory. Key Combo:

Press and hold  and  for 3 seconds to enter this mode.

NOTE TO SERIAL PORT USERS: It is essential to make the correct Year setting (see Section VI); otherwise, date data from the serial port may be incorrect.

XIII. Supplemental Wind Vane Calibration Adjustment

Your anemometer/wind vane has been factory-calibrated to correctly indicate wind direction when installed per the instructions on p. 17, and should not require recalibration. However, if you wish to adjust wind direction readings after installation (to correct a difference between display readings and actual wind direction) without physically realigning the sensor, you may use the following procedure.













1. Perform when you have a fairly steady breeze from a known direction.
2. Press  and  simultaneously to display the wind vane correction constant (the keyboard initially has a correction constant of zero).
3. Press and hold  or  to adjust the wind vane correction constant. After approximately 3 seconds the wind vane correction constant will start changing. Increase the number if you want the direction diamond on the display to move counter-clockwise to match actual wind direction. Decrease the number if you want the direction-indicating diamond to move clockwise to match actual wind direction.
4. Repeat Step 3 as necessary until the wind direction is correctly displayed. Record the Wind Vane Correction Constant below.
5. Press any function key to leave this operation and retain the correction constant that is displayed.

NOTE: The correction constant is a number between 0 and 255. Each digit represents approximately 1.4 angular degrees of correction ($360 \div 256$) that is added to the uncorrected wind direction.

Record your Wind Vane Correction Constant here _____

XIV. Supplemental Temperature Offset Adjustment

Your outdoor and indoor temperature sensors incorporate precision aged thermistors, which have been factory-calibrated to correctly indicate temperature when installed per the instructions on p. 18, and cannot be recalibrated. However, if you wish to adjust temperature readings after installation (to correct a difference between display readings and actual temperature, due to various mounting location factors) without physically relocating the sensor, you may use the following procedure.

1. Perform when you have a desired outdoor or indoor temperature value from a reliable standard in close proximity.
2. Press  and  simultaneously to display the previously-entered outdoor temperature offset (or press , , and  simultaneously to display the previously-entered indoor temperature offset). The keyboard initially has temperature offsets of zero.
3. Press and hold  and  (or press and hold , , and  for indoor temp) to adjust the temperature offset value. After approximately 3 seconds, the temperature offset value will start changing. Press  or  repeatedly to adjust the offset to equal the amount you wish to add or subtract from the base temperature reading.
4. Record the Outdoor and Indoor Temperature Offset values below, for future reference or re-input.
5. Press  to return to displaying the outdoor temperature and retain the offset value. Allow about 15 seconds for the displayed reading to reflect the offset.













NOTE: The temperature offset is number from -50°F through 50°F (-27°C and 28°C). The default on keyboard power-up is zero. The offset must be re-input after power-down has occurred.

Record your Outdoor Temperature Offset here _____

Record your Indoor Temperature Offset here _____

XV. Supplemental Humidity Offset Adjustment

Your outdoor and indoor humidity sensors have been factory-calibrated to correctly indicate relative humidity when installed per the instructions on p. 18, and should not require frequent recalibration. However, if you wish to adjust humidity readings after installation (to correct a difference between display readings and actual ambient humidity) without physically relocating the sensor, you may use the following procedure.

1. Perform when you have a desired outdoor or indoor humidity value from a reliable standard in close proximity.
2. Press  and  simultaneously to display the previously-entered outdoor humidity offset (or press , , and  simultaneously to display the previously-entered indoor humidity offset. The keyboard initially has a humidity offset of zero.
3. Press and hold  and  (or press and hold , , and  for indoor humidity) to adjust the humidity offset value. After approximately 3 seconds, the humidity offset value will start changing. Press  or  repeatedly to adjust the offset to equal the amount you wish to add or subtract from the base humidity reading.
4. Record the Outdoor and Indoor Humidity Offset values below, for future reference or re-input.
5. Press  to return to displaying the outdoor humidity and retain the offset value. Allow about 15 seconds for the displayed reading to reflect the offset.

NOTE: The humidity offset is a number from -50% through 50%. The default on keyboard power-up is zero. The offset must be re-input after power-down has occurred.

Record your Outdoor Humidity Offset here _____

Record your Indoor Humidity Offset here _____

XVI. ROUTINE MAINTENANCE

Care of Liquid Crystal Display

If the keyboard display unit's LCD becomes dirty, clean with a soft damp cloth only. Use no harsh or abrasive cleaners, as these will permanently scratch the surface of the display. Do not spray any liquids or cleaners directly on the display unit (especially the keyboard buttons).

Care of Anemometer/Wind Vane

The anemometer/wind vane is designed for years of reliable operation, with no scheduled maintenance required. It features bearings of durable acetal polymer and stainless steel balls, which require no lubrication. The introduction of oils or dry graphite lubricants into the bearings will tend to slow them down, resulting in inaccurate wind speed readings.

If you believe the anemometer's rotor or wind vane are not turning freely, you may remove them for inspection and cleaning as follows: Grasping the vane and rotor at the same time (in the palm of your hand), hook your fingers under the cup arms' retaining clips and pull upward. After overcoming initial resistance, the vane and rotor will be removed together. Remove any foreign material (i.e. cobwebs, soot, pollen, etc.) from inside the vane and rotor. The bearings may be cleaned using compressed air.

Do not use oil or dry graphite lubricants.

In Case of Non-Responsive Keyboard

Sometimes an electrical storm or line power surge can cause the keyboard to be disabled. To correct this condition, unplug the junction box cable from the back of the keyboard display and remove the 9-volt battery (however, be advised that all memories and initial settings will be lost). Install the battery again and reconnect the junction box cable.

NOTE: If you have adjusted wind direction calibration or entered temperature or humidity offsets (ref. page 41-43), it will be necessary to re-enter them after performing this procedure. Follow instructions on pp. 41-43. If the problem persists, please inquire about our special 4-Line Static Electricity Discharge Unit.

VII. REPAIR AND EXCHANGE SERVICE

In Case of a Problem

Your *ULTIMETER* 800 is designed to provide years of trouble free operation. If the instrument completely stops operating, the cause is probably inadequate power due to a faulty ac adapter, a faulty connection to the adapter, or weak or missing battery when operating from internal power. To correct the problem, disconnect all batteries and external power, then reapply proper power.

Also, be sure to see page 13 (crossed wires in receptacles) and page 8 ("Answers to Commonly-Asked Questions").

If a problem persists, please write or call our Technical Support Department at 1-866-446-1216. We will do everything possible to assure your satisfaction.

Repair and Exchange Service

Any defective *ULTIMETER* 800 may be repaired or exchanged for a factory reconditioned instrument of the same type with like-new performance. Under warranty there is no charge. Beyond warranty the charges are modest, depending upon the condition of the instrument.

Copyright 2006 Peet Bros. Company, Inc. All Rights Reserved.

WARRANTY

Each *ULTIMETER* 800 carries a limited warranty against defects of material or workmanship for a period of 1 year from the date of initial purchase. Our responsibility under this warranty is limited to the repair or replacement of instruments returned to us postage paid, together with proof of purchase date. This warranty shall not apply to instruments subjected to: improper installation, any alterations, misuse, tampering, or unauthorized service. It does not cover damage due to accidents, lightning, or other acts of God. Neither we nor our representatives, distributors, nor dealers shall be liable for any incidental or consequential damages. Some states do not allow the exclusion or limitation of incidental or consequential damages, so the above exclusion or limitation may not apply to you. This warranty gives you specific legal rights, and you may also have other rights which vary from state to state.

VIII. SPECIFICATIONS

Wind (PRO Anemometer)

Type:	3-Cup Anemometer, all digital, magnetically-actuated
Materials:	UV-Stabilized Polycarbonate, Acetal, 316 Stainless Steel
Cup Size:	2.6" diameter (6.6cm), 5.3 in ² (34cm ²) cross-sectional area
Vane Size:	12.9" (32.8cm) overall length, 3.5" (8.9cm) height, 13.8in ² (88.5 cm ²) surface area
Resolution:	0.1 mph (0.1 km/h, 0.1 m/s, 0.1 knots)
Speed Range:	0.2 to 160.0 mph (0.3 to 257.0 km/h, 0.1 to 71.0 m/s, 0.2 to 139.0 knots)
Threshold:	1.5 mph (2.4 km/h, 0.6 m/s, 1.3 knots)
Update Interval:	0.5 seconds, typical (more often at speeds >5 mph)
Accuracy:	± 2 mph (± 3.2 km/h, ± 0.9 m/s, ± 1.7 knots) or ± 5%, whichever is greater
Speed Data:	Current ^{1,2} , 1-min Peak and associated Direction ² , 1-min Avg ² , 5-min Peak and associated Direction ² , 5-min Avg ² , Daily Peak and associated Direction ^{1,2} (8 days' Peaks stored in keyboard memory), Long-Term Peak and associated Direction ^{1,2}
Direction:	Digital magnetic sensor, with 16-point analog "compass rose" display ¹ , and numeric "degrees" display ^{1,2} with 1° resolution, ± 5% accuracy
Cable:	40 ft., 4-conductor, unshielded w/modular plug

Wind (Standard Anemometer)

Type:	3-Cup Anemometer, all digital, magnetically-actuated
Materials:	UV-Stabilized Polycarbonate, Acetal, 316 Stainless Steel
Cup Size:	1.2" diameter (3.2cm), 1.2 in ² (7.8cm ²) cross-sectional area
Vane Size:	6.2" (15.7cm) overall length, 2.8" (7.1cm) height, 6.8in ² (43.6 cm ²) surface area
Resolution:	1 mph (1 km/h, 1 m/s, 1 knot)
Speed Range:	2 to 175 mph (3 to 282 km/h, 1 to 78 m/s, 2 to 152 knots)
Threshold:	3 mph (5 km/h, 1 m/s, 3 knots)
Update Interval:	1 second, typical (more often at speeds >10 mph)
Accuracy:	± 2 mph (± 3 km/h, ± 1 m/s, ± 2 knots) or ± 5%, whichever is greater
Speed Data:	Current ^{1,2} , 1-min Peak and associated Direction ² , 1-min Avg ² , 5-min Peak and associated Direction ² , 5-min Avg ² , Daily Peak and associated Direction ^{1,2} (8 days' Peaks stored in keyboard memory), Long-Term Peak and associated Direction ^{1,2}
Direction:	16-point analog "compass rose" display ¹ , and numeric "degrees" display ^{1,2} w/1° resolution, ± 5% accuracy
Cable:	40 ft., 4-conductor, unshielded w/modular plug

¹Data displayed in keyboard LCD

²Data available in RS232 Output

^{1,2}Data displayed in LCD and available in RS232 Output

Outdoor Temperature

Type:	Precision aged Thermistor
Materials:	Nickel-plated Steel Probe housing, 24-gauge copper cable
Resolution:	1°F ¹ (0.1°C ¹), 0.1°F ² (0.1°C) ²
Range:	-55°F to +150°F (-48°C to +66°C)
Accuracy:	± 1°F (± 0.5°C)
Data:	Current ^{1,2} , Today's High and Low w/time occurred (since 12:00am) ^{1,2} , Daily Highs and Lows w/time occurred ^{1,2} (each of previous 7 days), and Long Term Highs and Lows w/time occurred ^{1,2} (since user reset)
Cable:	25 ft., 4-conductor w/modular plug termination

Wind Chill

Basis:	Derived from ambient air temperature and instantaneous wind speed
Index:	US National Weather Service Wind Chill Index (adopted November 2001, and valid for air temperatures below 50°F) <u>Note:</u> by definition, above +50°F(+10°C), the Wind Chill Temperature is identical to the ambient air temperature
Resolution:	1°F ¹ (0.1°C ¹), 0.1°F ² (0.1°C) ²
Range:	-99°F to +50°F (-72°C to +10°C) See note above
Accuracy:	± 1°F (± 0.5°C)
Data:	Current ^{1,2} , Today's Low w/time occurred (since 12:00am) ^{1,2} , Daily Lows w/time occurred ^{1,2} (each of previous 7 days), and Long Term Low w/time occurred ^{1,2} (since user reset)

Indoor Temperature

Type:	Precision aged Thermistor, located inside keyboard/display
Resolution:	1°F ¹ (0.1°C ¹), 0.1°F ² (0.1°C) ²
Range:	32°F to +110°F (0°C to 43°C)
Accuracy:	± 1°F (± 0.5°C)
Data:	Current ^{1,2} , Today's High and Low w/time occurred (since 12:00am) ^{1,2} , Daily Highs and Lows w/time occurred ^{1,2} (each of previous 7 days), and Long Term Highs and Lows w/time occurred ^{1,2} (since user reset)

Barometric Pressure (ULTIMETER 2100 only)

Type:	Precision electronic absolute pressure transducer, located within keyboard/display unit
Resolution:	0.1 hPa/mbar, 0.1 inHg 0.1 mmHg
Range:	931.3 to 1067.0 hPa/mbar, 27.5 to 31.5 inHg 698.5 to 800.0 mmHg
Accuracy:	± 1.7 hPa/mbar, ± 0.05 inHg, ± 1.3 mmHg (at room temperature)
Data:	Current ^{1,2} , 3-hr Change ^{1,2} , Daily High/Low ^{1,2} (8 days), Long-Term High/Low ^{1,2}

¹Data displayed in keyboard LCD

²Data available in RS232 Output

^{1,2}Data displayed in LCD and available in RS232 Output

Rain Gauge, PRO (optional sensor)

Type:	Drop-counting electronic rain gauge, 3.2"dia (8.1cm) funnel
Resolution:	0.001 inches (.025mm), 0.01 inch (.25mm) increments
Range:	0.00 to 199.99 inches (0.00 to 1999.9mm) accumulation
Accuracy:	± 5%, at rain rates up to 10" (254mm) per hour
Data:	Today's Rainfall (since 12:00am) ^{1,2} , 3-hr Change ^{1,2} , Daily Rainfall ^{1,2} (each of previous 7 days), and Long Term Rainfall ^{1,2} (since user reset)
Units:	inches, millimeters
Cable:	40 ft., 4-conductor w/modular plug termination

Rain Gauge, TB (optional sensor)

Type:	Electronic Tipping Bucket rain gauge, US NWS compliant 8"dia (20.3cm) funnel
Resolution:	0.01 inch (.25mm) increments
Range:	0.00 to 199.99 inches (0.00 to 1999.9mm) accumulation
Accuracy:	± 1.5%, at rain rates up to 0.5" (13mm) per hour ± 5%, at rain rates up to 5" (127mm) per hour
Data:	Today's Rainfall (since 12:00am) ^{1,2} , 3-hr Change ^{1,2} , Daily Rainfall ^{1,2} (each of previous 7 days), and Long Term Rainfall ^{1,2} (since user reset)
Units:	inches, millimeters
Cable:	40 ft., 4-conductor w/modular plug termination

Rain Gauge, Other (optional sensor)

Type:	Other manufacturers' rain gauges can be interfaced
Increments:	0.1", 0.01", 2.5mm, .25mm, 0.1mm (user selectable to match rain gauge increments)

Outdoor Humidity/Temperature (optional sensor)

Type:	Capacitive RH Sensor, Precision aged Thermistor
Materials:	UV-stabilized ABS housing, 24-gauge copper cable, conformal-coated circuit assembly, stainless steel vents
Resolution:	1°F ¹ (0.1°C ¹), 0.1°F ² (0.1°C) ² , 1% R.H.
Range:	Temperature -55°F to +150°F (-48°C to +66°C), Relative Humidity 0 to 100%
Accuracy:	Temperature ± 1°F (± 0.5°C), R.H. ± 4%
Dew Point:	derived from ambient temperature and relative humidity; same units as temperature
Heat Index:	derived from ambient temperature and relative humidity; same units as temperature
Data:	Current Temp, R.H. Dew Point, Heat Index ^{1,2} , Today's High and Low Temp & R.H. w/time occurred (since 12:00am) ^{1,2} , Daily High and Low Temp & R.H. w/time occurred ^{1,2} (each of previous 7 days), and Long Term High and Low Temp & R.H. w/time occurred ^{1,2} (since user reset)
Cable:	40 ft., 4-conductor w/modular plug termination

¹Data displayed in keyboard LCD

²Data available in RS232 Output

^{1,2}Data displayed in LCD and available in RS232 Output

Indoor Humidity (optional sensor)

Type: Capacitative RH Sensor
Materials: UV-stabilized ABS housing, 24-gauge copper cable, sintered plastic vents
Resolution: 1% R.H.
Range: Relative Humidity 0 to 100%
Accuracy: R.H. \pm 4%
Data: Current^{1,2}, Today's High and Low w/time occurred (since 12:00am)^{1,2}, Daily Highs and Lows w/time occurred^{1,2} (each of previous 7 days), and Long Term Highs and Lows w/time occurred^{1,2} (since user reset)
Cable: 20 ft., 4-conductor w/modular plug termination

¹Data displayed in keyboard LCD

²Data available in RS232 Output

^{1,2}Data displayed in LCD and available in RS232 Output

Control Unit

Size: 6-3/4" x 2-3/4" x 1-1/4", Desk or Wall Mounted
Display: Backlit Liquid Crystal
Numeral Size: .5" high
Keypad: 16-button, illuminated buttons
Sensor Interface Jack: 10P10C (for 10-conductor cable to Junction Box)
Serial Port: RS232 I/O port, RJ12 modular jack

Junction Box

Has receptacles for external power and all outside sensors.
RS232 Serial Data I/O port (RJ12 modular jack)
Built-in Static Electricity Discharge Protection
Size: 4" x 1-3/4" x 7/8"

Primary Power

AC adapter 12 v DC output

Back-up Power

Provision for 9-volt alkaline battery

Serial Data Output

RS232 compatible UART, user-selectable 2400 or 19200 baud, 8-N-1

Optional Accessories

- Indoor Humidity Sensor
- Outdoor Humidity/Temperature Sensor
- Self-emptying Rain Gauges - several models available, including heated
- The Weather Picture®
- WeatherText™ Tools PC Data Logger Kit
- The WeatherVox – a "speech synthesized" weather reporting device

Specifications necessarily subject to change without notice. Protected under one or more of the following patents: US 05361633, US 05231876, US 05033402, US 05001929, and US 04969358

IX. AVAILABLE ACCESSORIES

We are continually developing new products and accessories to make your *ULTIMETER* 800 Weather Station more interesting and valuable to you. Some of our most popular items are:

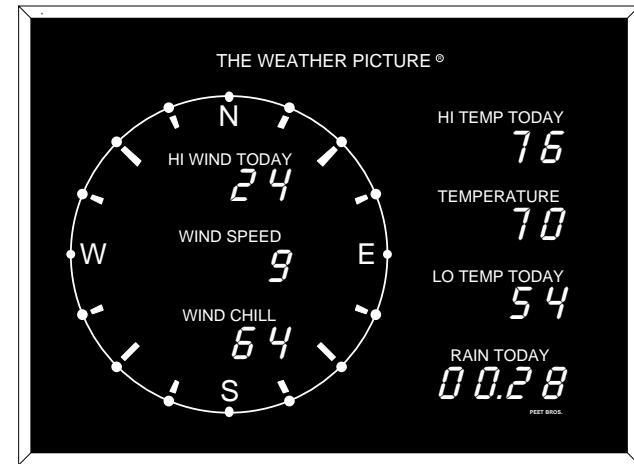

THE WEATHER PICTURE

Finally a *big* weather display you can read from across the room - and handsome enough for any setting. THE WEATHER PICTURE displays information it receives from an *ULTIMETER* Weather Station, continuously providing and updating all the vital weather data you have pre-selected, without having to press a single key.

Its 8" compass rose and large 0.8" illuminated red numerals are clearly visible, day and night. THE WEATHER PICTURE is **perfect for homes as well as schools, hotels, offices, country clubs, stores, marinas, corporate lobbies, ski lodges, emergency management stations, etc.** - any place needing up-to-the-second *local* weather data. Can be totally customized to display any of over 60 weather functions on each numeric display. Available in two frame styles (brushed aluminum and traditional oak).

Self-Emptying Rain Gauge: TB, PRO, or Heated PRO

Automatically empties itself every 0.01" of rain and sends a signal to the keyboard/display unit, which maintains NINE independent rain totals: today's total rainfall, each of the previous 7 day's totals, and long-term total (since last reset).

Outdoor Relative Humidity and Temperature Sensor

Employing the latest in relative humidity, dew point, and temperature measurement technology, this instrument utilizes a precision thermistor and gold-plated humidity sensor. Factory calibrated, w/40' cable. Solar Shielded version available.

Indoor Humidity Sensor

Same relative humidity sensor technology as above, but designed for monitoring indoor humidity. 20' cable can be extended to monitor a remote solarium, patient's room, wine cellar, library, etc.

Duplex Cable

Allows both an indoor humidity sensor and a data logger cable or other serial I/O device to be connected simultaneously to the receptacle on the right side of the keyboard. Or, allows a Weather Picture and other serial I/O device to be connected simultaneously to the "i/o" receptacle of the junction box.

WeatherText™ Tools PC Data Logger Kit

Special cable and software to record weather data on a personal computer. Generate csv or text weather data files, automatically email weather reports, and upload to website via FTP. Display and analyze logged data in graphic or tabular form using any popular spreadsheet program.

Splitter Junction Box

Allows the operation of a second keyboard/display unit, for installation in another room or adjacent building.

Radio Frequency Interference Filter

If the *ULTIMETER* 800 is used near an extremely powerful radio transmitter, its high and low temperature readings can be affected. This would normally only be encountered in the immediate vicinity of commercial radio or TV stations, or high-power ham radio transmitters. If you think you are experiencing this problem, please inquire about our inexpensive, 30 dB 4-line RFI filter.

For additional information about these or other accessories, please contact your *ULTIMETER* 800 dealer or Peet Bros. Company. We'll be happy to advise you of latest developments and answer any questions you may have.